

SCHMIDT[®] Presses

Simply the best!

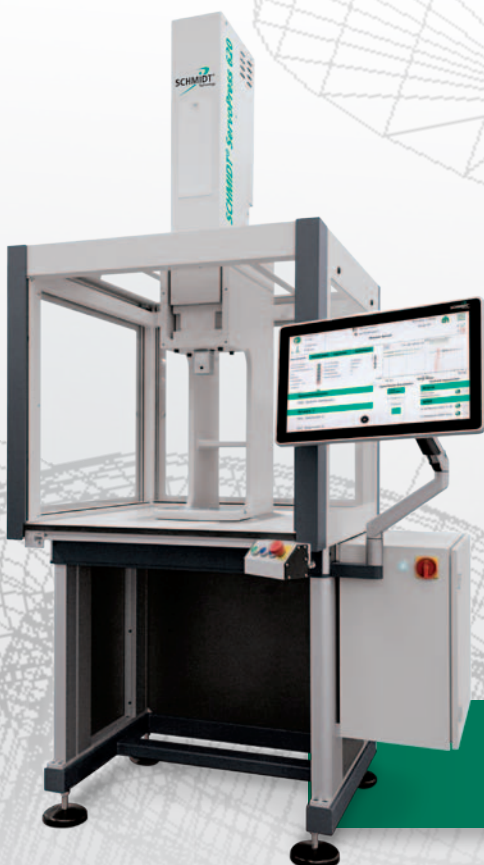
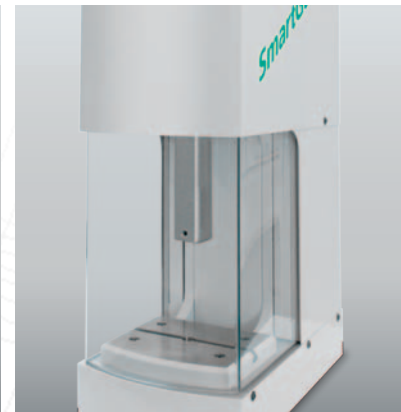

Presses, Control Units, Safety & more
Complete solutions from a single source

Table of Contents



Introduction I

ManualPress II

- Rack-and-Pinion Presses 02
- Toggle Presses 04
- NockenPresse 11N 10
- DuplexPress 8 12
- ManualPress 305, 307, 311 with Process Monitoring 16

Hydro-/Pneumatic Presses III

- PneumaticPress Direct Acting Presses 04
- PneumaticPress Toggle Presses 08
- PneumaticPress Force/Stroke Monitoring 12
- HydroPneumaticPress C-Frame Design 18
- HydroPneumaticPress Force/Stroke Monitor. 22
- HydroPneumaticPress H-Frame Design 26
- Cylinder Units 28

Electric Presses IV

- ElectricPress 01
- ServoPress 06
- TorquePress 12

Control Units V

- PressControl 75 02
- PressControl 700 03
- PressControl 7000 04
- Visualization & Process Analysis 07
- Software Tools, PRC DataBase 08
- PRC FileXchange, PRC OPC UA 09
- PRC DataXchange 10
- PRC OpenFieldBus 10
- Hardware Tools 11

Safety Concepts, Single Workstations VI

- Single Workstations 01
- SmartGate 02
- SmartGuard 03
- Lichtvorhang 04
- 2-hand release 06
- Press Bases, Four-column Gantry 06
- Slide Tables 07
- Customer-Specific Solutions 08
- Support 10
- Service 11

Family-Run Company

As internationally accepted Technology Leader



SCHMIDT Technology is a family-run, medium-sized enterprise at the highest technological level. The success speaks for itself: Today, products and services from **SCHMIDT Technology** are exported to over 80 countries of the world.

The safety and quality of **SCHMIDT Technology** products make them unique on the global market and thus sought after for decades. The international orientation of the company and the combination of creative and intelligent solutions, together with economic and efficient manufacturing in Germany, lay the groundwork for the successful future-oriented position of the enterprise.

Because of this, **SCHMIDT Technology** is valued internationally as a solid, dependable and competent partner. The outstanding characteristics of a successful company must include a strong visionary innovation potential.

SCHMIDT Technology recognized this at an early stage and invested ardently in the fields of research and development. At the same time, the company traditionally keeps in close contact with external research institutes and universities.

As a result, the name **SCHMIDT Technology** is associated with highest quality standards worldwide. In keeping with this, **SCHMIDT Technology** holds all relevant quality certificates such as DIN EN ISO 9001.

Your profitability Is our top priority

The task to assemble two or more components requires a careful decision about the joining method. Traditional processes such as bolting, soldering, welding or glueing are continuously being replaced with cost effective and efficient pressing operations.

These are exactly our strengths.

Use our knowledge for your application

The right press type can be chosen depending on the application. Today, **SCHMIDT® Presses** stand for first-class assembly technology worldwide. This applies both for stand-alone machines and for assembly modules integrated in complex automation lines.

SCHMIDT Technology a leader in intelligent joining technology, has the widest product range of all producers. From **SCHMIDT® ServoPress** and **SCHMIDT® HydroPneumaticPress** or **SCHMIDT® PneumaticPress** and **SCHMIDT® ElectricPress** up to our **SCHMIDT® ManualPress** range, our solutions are tailored to meet all of your process requirements. Apart from the presses, the safety and control technology of the **SCHMIDT® PressesControl** sets standards due to its system philosophy, force/stroke monitoring and integrated measurement technology. A continuous process control and the essential ISO-conforming documentation are the tools for high productivity in today's efficient assembly. These performance features make **SCHMIDT Technology** the undisputed technological leader in the field of precision joining technology today.

This is the basis for the excellent reputation of **SCHMIDT Technology**, specifically in the key sectors such as automobile technology, aerospace technology, electrics/electronics, micro-mechanics and medical technology.

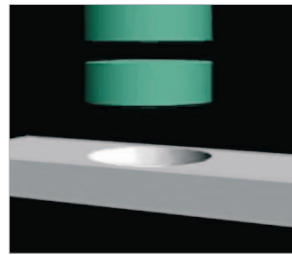
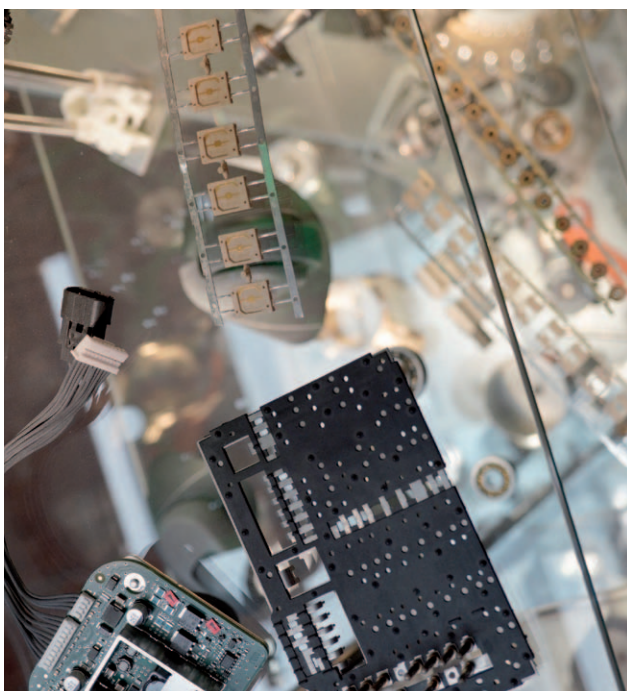

Pressing



Snap Fitting

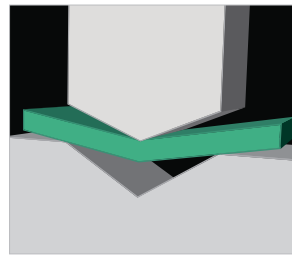

Forming

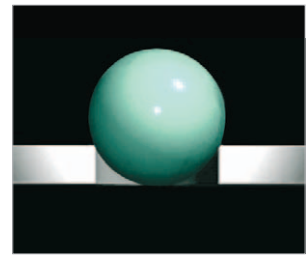

Forming Calibrating / Sizing

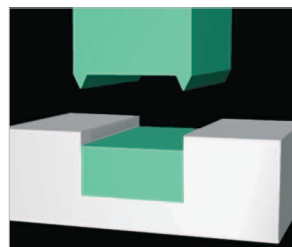

Crimping

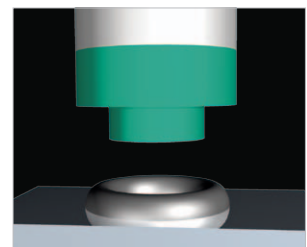

Flaring

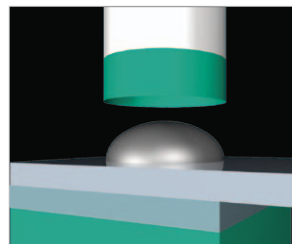

Riveting



Punching

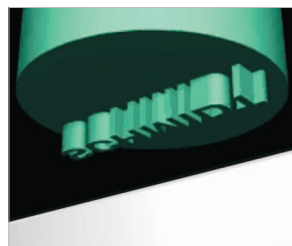

Marking



Cutting

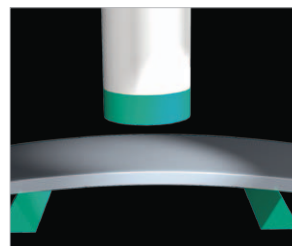

Bending

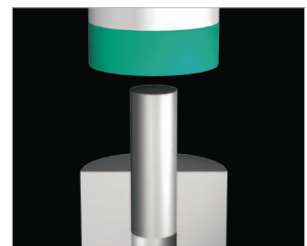

Joining

In Partnership To Success

A global market requires linked processes. Thanks to the OPC connection via Ethernet technology, you can access your process data at any time. Furthermore, local representation and rapid response are essential. Our worldwide distribution network of subsidiaries and trained sales & support partners ensure that our customers will receive full support for all their requirements. All our representatives' support teams have been trained specifically on our products.

Deciding in favour of our technology is the first step to a successful partnership.

The economic success is then shown in daily production. High quality products optimized for assembly processes are as important as an efficient after-sales service. Our name is your guarantee.



Safety? Absolutely no compromises!

We offer assembly systems that comply with the latest EC Machinery Directives.

As a pioneer in operator and machine safety, process stability, and ergonomics, it's no surprise that we not only meet the standards but also exceed them.

Safety and the health of operators are paramount to us, and we believe that no compromises should be made in this regard.

Skills to your advantage

All our training centers provide machinery and full expertise to assist our customers with their applications.

On this basis, a team of skilled engineers plan economic solutions from the simple manual workstation to the fully automated assembly line.

Competent technical customer service is our strength. We offer training courses and seminars in our **SCHMIDT® TrainingCenters**. Your employees will achieve sustainable knowledge of the presses and their practical use resulting in a benefit for your products.



SCHMIDT® ManualPress

From 1.6 kN to 22 kN

Efficient manufacturing requires appropriate means of production – not always automation. In particular, with small production runs, manual presses are often the most cost effective solutions.

We are continually developing the range of manual presses so that you can achieve your production targets. The expertise we have gained from our exposure to numerous production applications has been implemented in our new models. Therefore, we can offer a wide range of manual presses to suit all requirements.

Characteristics

- Flexibility
 - Rapid changeover due to the easy and secure adjustment of the working height
 - Table tops with precision T-slot and precise alignment between the ram and table bores allow for accurate and repeatable set ups which reduces set-up times
 - The original position of the hand lever can be varied by 360°
 - Horizontal pull (111/113)
 - Available for left-handed and right-handed use
 - The return stroke force of the ram can be adapted to different tool weights
- Precision
 - Alignment < 0.05 mm between upper and lower tool
- Maintenance-free
 - No lubrication necessary
- Long service life

Depending on the application, there is a wide selection of rack-and-pinion presses and toggle presses to choose from. Furthermore, a modular product design gives you the opportunity to choose the appropriate press for your application.



SCHMIDT® Rack-and-Pinion Presses

Constant force over the entire stroke

Do you need force over a longer stroke distance for assembly processes? Then **SCHMIDT® Rack-and-Pinion Presses** are the right choice.

Characteristics

- Long stroke
- Linear force progression
- Precise adjustment of the press depth via an integrated hardened adjustable stop
- Honed ram guiding and ground rams provide a long service life and a precise guidance

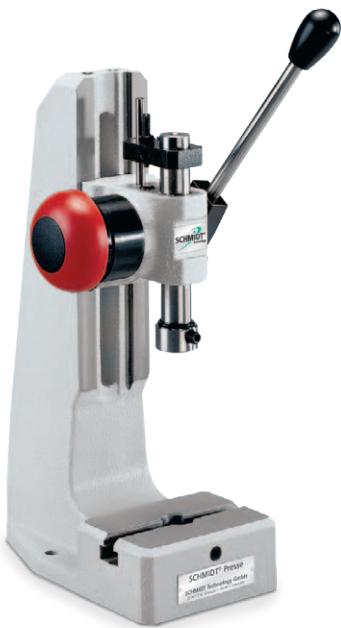

Press Type 5



Press Type 3 or 6



Press Type 1 or 2



Improved return stroke mechanism for rack-and-pinion presses No. 3 and 6 with stroke 100 mm and 160 mm

The use of a spring package optimized specifically for large strokes improves ergonomics significantly. In addition, the use of the **Ergohandle** ensures that even with angles of rotation $>360^\circ$, no switching of hand position is necessary. The force feedback on the hand lever is kept as constant as possible over the entire stroke by a balance weight.



Press Head

No.1 and No.2 have a ground guidance plate and teflon-coated adjustable gibbs for precise and torsion-proof guidance.

From 1.6 kN to 2.5 kN

Press Type		5	5R	3	3R	6	6R	1	1R	2	2R
Press head type		5	5R	3	3R	3	3R	1	1R	1	1R
Nominal force	kN	1.6	1.6	2.4	2.4	2.4	2.4	2.5	2.5	2.5	2.5
Working stroke up to	A mm	40	40	70	70	70	70	80	80	80	80
				160	100	160	100	100	100	100	100
Press head height	S mm	240	240	350	350	350	350	400	400	400	400
				350	350	350	350				
Throat depth	C mm	65	65	86	86	86	86	86	86	86	86
Ram bore	Ø mm	10H7	10H7	10H7	10H7	10H7	10H7				
Collet (standard Ø10)	Ø mm							1-17	1-17	1-17	1-17
Hand lever left		○	○	○	○	○	○	●	●	●	●
Angle of rotation/mm stroke		4.1°	4.1°	3.2°	3.2°	3.2°	3.2°	2.2°	2.2°	2.2°	2.2°
Max. weight of the upper tool ²⁾	kg	1.5	1.0	2.5	2.0	2.5	2.0	1.0	1.0	1.0	1.0
Return stroke lock¹⁾											
Minimum working stroke	mm		17		18		18		26		26
Locked position 1	mm bef. BDC		11.5		13		13		19.5		19.5
Locked position 2	mm bef. BDC		3.5		4.5		4.5		7		7
Disengaging accuracy	mm		0.06		0.07		0.07		0.08		0.08
Working height³⁾	F										
Frame No. 13	mm	55-200	55-200					120-260	120-260		
Frame No. 3	mm			75-220	75-220						
Frame No. 2	mm					100-355	100-355			145-360	145-360
Frame No. 2-600 ○	mm			200-600	200-600	200-600	200-600	245-650	245-650	245-650	245-650
Frame No. 2-1000 ○	mm			330-1030	330-1030	330-1030	330-1030	380-1080	380-1080	380-1080	380-1080
Weight	approx. kg	11	11	22	22	30	30	23	23	31	31

Accessories	5	5R	3	3R	6	6R	1	1R	2	2R
Mechanical counter	○	○	○	○	○	○	○	○	○	○
Throat depth frame (total depth) 111 mm, 131 mm, 160 mm, 200 mm			○	○	○	○	○	○	○	○
Additional fixture mounting plate suitable for throat depth frame			○	○	○	○	○	○	○	○
Micrometer stop	○	○	○	○	○	○				

Frame Overview	Press Type	Frame Height M without height adj. (mm)	Table Size B x T (mm)	Table Bore D (Ø mm)	Table Height K (mm)	Mounting Surface B x L (mm)
No. 13	5	330	110 x 80	20H7	46	110 x 185
No. 3	3, 1	400	150 x 110	20H7	60	150 x 260
No. 2	6, 2	536	185 x 110	20H7	60	185 x 280
No. 2-600	3, 6, 1, 2	810	200 x 160	20H7	98	200 x 290
No. 2-1000	3, 6, 1, 2	1250	200 x 160	20H7	98	200 x 290

Options

- Series with no additional charge ○ Additional charge applies
- ¹⁾ Adjustment of locking position on request
- ²⁾ The weight was determined with hand lever position 45° forward (guide)
- ³⁾ Typical values; can vary ± 3 mm due to casting and production tolerances

Other available options

- Nickel plated – cast parts are electroless nickel plated, steel components black oxide finished, aluminum anodized, precision steel surfaces are untreated
- Custom paint – press and column can be painted to customer's color specification
- Bores for adapting tooling – customer specific sizes can be supplied

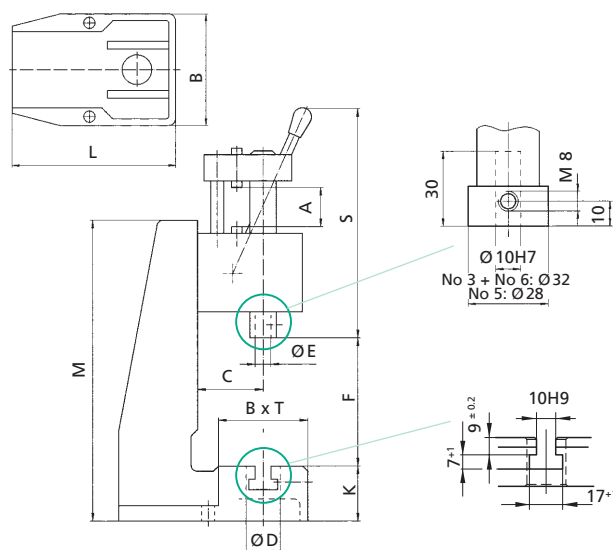
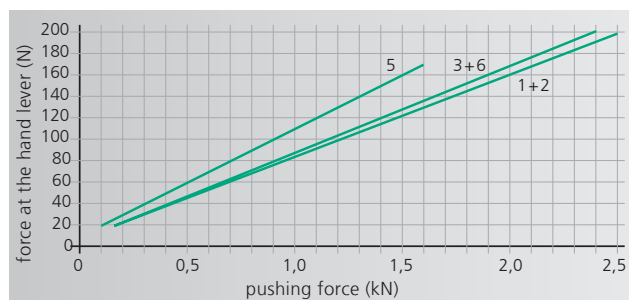

Detailed dimensional drawings can be downloaded: www.schmidttechnology.de

SCHMIDT® Toggle Presses

The high force at the end of stroke, just where it is important

Do you need a high force at the end of stroke for material transforming processes? Then **SCHMIDT® Toggle Presses** are just the right choice.

Characteristics

- High force at the end of stroke (see diagram below)
- Honed bores and ground rams provide a long service life and a precise guidance



Press Type 13RFZ



Press Type 11 / 14 - 17

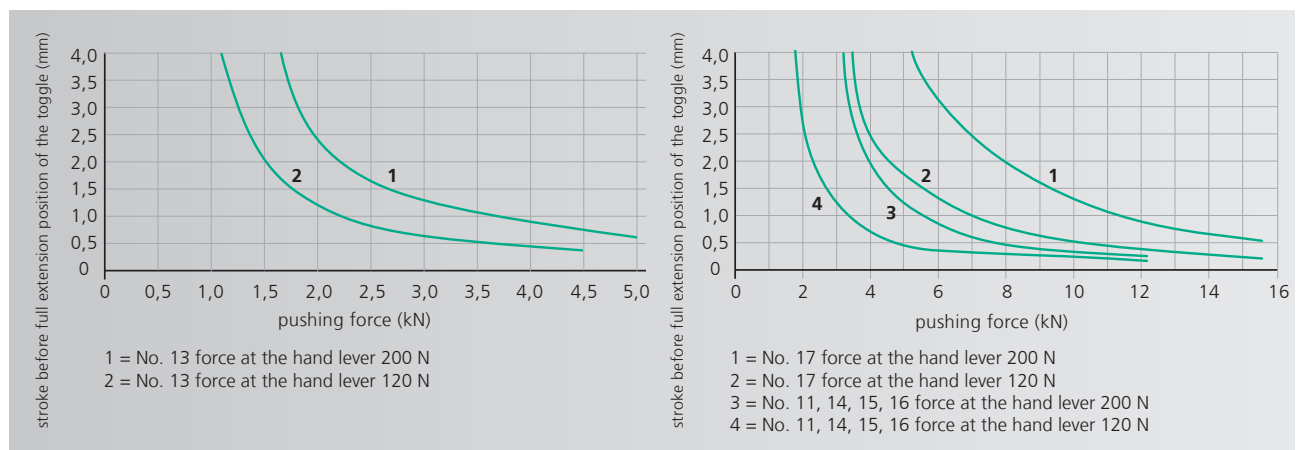

Maximum force will be reached just before extended position

From 5 kN to 15 kN

Press Type		13	13R	11	11R	15	15R	14	14R	16	16R	17
		13F	13RF	11F	11RF	15F	15RF	14F	14RF	16F	16RF	17F
Press head type		13-40 13F-35	13R-40 13RF-35	11-45 11F-35	11R-45 11RF-35	11R-45 11F-35	11R-45 11RF-35	11-60 11F-50	11R-60 11RF-50	11-60 11F-50	11R-60 11RF-50	11-20 11F-20
Nominal force	kN	5	5	12	12	12	12	12	12	12	12	15
Working stroke up to	A mm	40 35	40 35	45 35	45 35 ⁵⁾	45 35 ⁵⁾	45 35 ⁵⁾	60 50	60 50	60 50	60 50	20 20 ⁵⁾
Throat depth	C mm	65	65	86	86	86	86	86	86	86	86	86
Press head height	S mm	385 400	385 400	520 540	520 540	520 540	520 540	500 520	500 520	500 520	500 520	620 640
Ram bore	Ø mm	10H7	10H7	10H7	10H7	10H7	10H7	10H7	10H7	10H7	10H7	10H7
Hand lever left		o		o		o		o		o		
Angle of rotation		95°	95°	110°	110°	110°	110°	125°	125°	125°	125°	90°
Max. weight upper tool ³⁾ standard / reinforced spring	kg	1.2/3.5 1.5/3	1.2/3.5 1.5/3	2/4.5 2.5/6	2/4 2/6	2/4.5 2.5/6	2/4 2/6	1.5/2.5 2/5	1.5/2.5 1.5/4	1.5/2.5 2/5	1.5/2.5 1.5/4	2.5/- 2.5/-
Return stroke lock¹⁾												
Minimum working stroke	mm		25		20		20		24		24	
Locked position 1	mm bef. DC		13.5		12		12		14		14	
Locked position 2	mm bef. DC		1.5		1.5		1.5		1.5		1.5	
Disengaging accuracy	mm		0.03		0.03		0.03		0.04		0.04	
Working height⁴⁾	F											
Frame No. 13	mm	65-180 40-155	65-180 40-155									
Frame No. 3	mm			75-210 50-185	75-210 50-185			90-220 65-195	90-220 65-195			65-200 50-185
Frame No. 5	mm											65-315 50-300
Frame No. 2	mm					100-345 80-325	100-345 80-325			110-360 85-335	110-365 85-335	
Frame No. 2-600 o	mm			200-585 175-560	200-585 175-560	200-585 175-560	200-585 175-560	210-595 185-570	210-595 185-570	210-595 185-570	210-595 185-570	190-575 175-560
Frame No. 2-1000 o	mm			330-1020 305-1000	330-1020 305-1000	330-1020 305-1000	330-1020 305-1000	340-1030 315-1010	340-1030 315-1010	340-1030 315-1010	340-1030 315-1010	315-1015 300-1000
Weight	approx. kg	12	12	23	24	29	29	24	24	29	29	23

Accessories	13	13R	11	11R	15	15R	14	14R	16	16R	17
	13F	13RF	11F	11RF	15F	15RF	14F	14RF	16F	16RF	17F
Mechanical counter	o	o	o	o	o	o	o	o	o	o	o
Throat depth frame (total depth) 111 mm, 131 mm			o	o	o	o	o	o	o	o	o
Additional fixture mounting plate suitable for throat depth frame			•	•	•	•	•	•	•	•	•
Block clamping piece ²⁾	o o	o o	• •	• •	• •	• •	o o	o o	o o	o o	• •

Frame Overview	Press Type	Frame Height M (mm)	Table Size B x T (mm)	Table Bore D (Ø mm)	Table Height K (mm)	Mounting Surface B x L (mm)
No. 13	13	475	110 x 80	20H7	46	110 x 185
No. 3	11, 14, 17	540	150 x 110	20H7	60	150 x 260
No. 5	17	536	185 x 110	20H7	60	185 x 275
No. 2	15, 16	700	185 x 110	20H7	60	185 x 280
No. 2-600	11, 14, 15, 16, 17	974	200 x 160	20H7	98	200 x 290
No. 2-1000	11, 14, 15, 16, 17	1410	200 x 160	20H7	98	200 x 290

Options

- Series with no additional charge o Additional charge applies
- ¹⁾ Adjustment of locking position on request
- ²⁾ Stroke reduction about 10 mm by version with additional charge
- ³⁾ The weight was determined with hand lever position 45° forward (guide)
- ⁴⁾ Typical values; can vary ± 3 mm due to casting and production tolerances
- ⁵⁾ Stroke adjustable with stop clamp (in the scope of delivery)

Other available Options

- Nickel plated – cast parts are electroless nickel plated, steel components black oxide finished, aluminum anodized, precision steel surfaces are untreated
- Custom paint – press and column can be painted to customer's color specification
- Bores for adapting tooling – customer specific sizes can be supplied

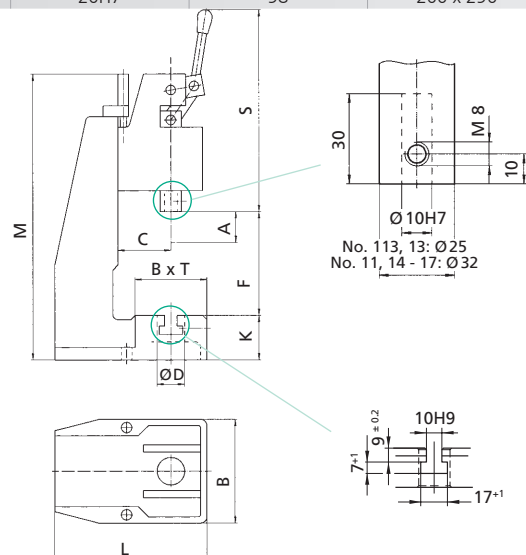

Detailed dimensional drawings can be downloaded: www.schmidttechnology.de

SCHMIDT® Toggle Presses with Horizontal Pull

The high force at the end of stroke, just where it is important

Do you need a high force at the end of stroke for material transforming processes? Then **SCHMIDT® Toggle Presses** are just the right choice.

Characteristics

- High force at the end of stroke (see diagram below)
- Honed bores and ground rams provide a long service life and a precise guidance



Press Type 113RFZ



Press Type 111RF

Ergonomic Press with horizontal pull

With press No. 113 and No. 111 the manual force is applied by pulling the lever towards the body. This press is especially suitable for rapid production at small forces. We supply press No. 111 including the ergonomic handle (standard scope of supply).

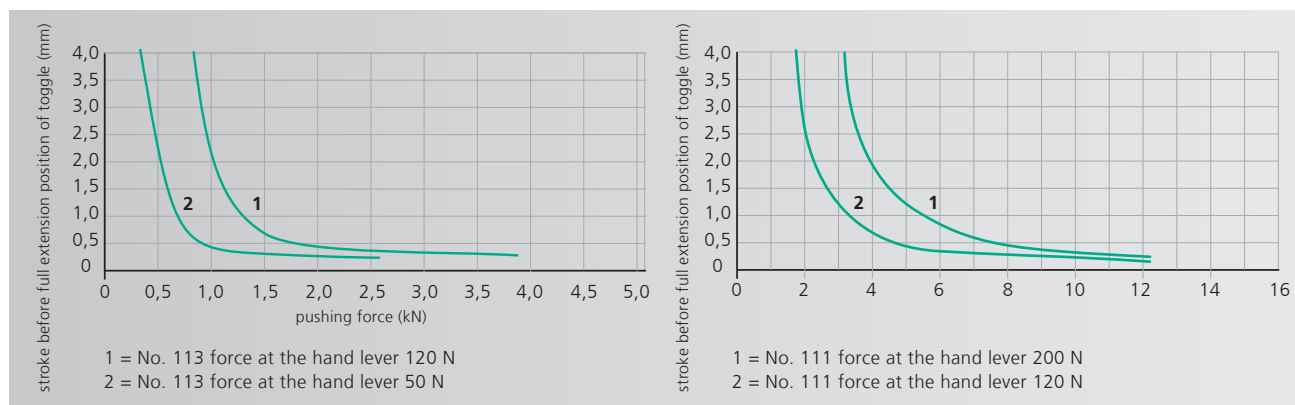

Maximum force will be reached just before extended position

From 2.5 kN to 12 kN

Press Type			113 113F	113R 113RF	111 111F	111R 111RF
Press head type			113 113F	113R 113RF	111 - 45 111F - 50	111R - 45 111RF - 50
Nominal force		kN	2.5	2.5	12	12
Working stroke up to ⁵⁾	A	mm	28 28	28 28	45 50	45 50
Throat depth	C	mm	65	65	86	86
Press head height	S	mm	170 180	190 200	215 225	240 250
Ram bore	∅	mm	10H7	10H7	10H7	10H7
Hand lever left			-	-	-	-
Angle of rotation			80°	80°	90°	90°
Max. weight upper tool ³⁾ standard / reinforced spring		kg	1/3 0.6/3	0.5/2.5 0.6/3	2.5/- 3/-	2.5/- 3/-
Return stroke lock¹⁾						
Minimum working stroke		mm		22		24
Locked position 1		mm bef. BDC		12		14
Locked position 2		mm bef. BDC		0.5		1.5
Disengaging accuracy		mm		0.03		0.07
Working height⁴⁾						
Frame No. 13		mm	50-165 40-155	50-165 40-155		
Frame No. 3		mm			120-205 105-195	120-205 105-195
Frame No. 2		mm			120-345 105-335	120-345 105-335
Frame No. 2-600 ○		mm			200-580 185-570	200-580 185-570
Frame No. 2-1000 ○		mm			330-1020 310-1000	330-1020 310-1000
Weight		approx. kg	11	11	28	28

Accessories	113 113F	113R 113RF	111 111F	111R 111RF
Mechanical counter	○	○	○	○
Throat depth frame (total depth) 111 mm, 131 mm			○	○
Additional fixture mounting plate suitable for throat depth frame			○	○
Block clamping piece ²⁾	● ○	● ○	● ○	● ○

Frame Overview	Press Type	Frame Height M (mm)	Table Size B x T (mm)	Table Bore D (∅ mm)	Table Height K (mm)	Mounting Surface B x L (mm)
No. 13	113	475	110 x 80	20H7	46	110 x 185
No. 3	111	540	150 x 110	20H7	60	150 x 260
No. 2	111	700	185 x 110	20H7	60	185 x 280
No. 2-600	111	974	200 x 160	20H7	98	200 x 290
No. 2-1000	111	1410	200 x 160	20H7	98	200 x 290

Options

- Series with no additional charge ○ Additional charge applies
- ¹⁾ Adjustment of locking position on request
- ²⁾ Stroke reduction about 10 mm by version with additional charge
- ³⁾ The weight was determined with hand lever position 45° back (guide)
- ⁴⁾ Typical values; can vary ± 3 mm due to casting and production tolerances
- ⁵⁾ Stroke adjustable with stop clamp (in the scope of delivery)

Other available options

- Nickel plated – cast parts are electroless nickel plated, steel components black oxide finished, aluminum anodized, precision steel surfaces are untreated
- Custom Paint – Press and column can be painted to customer's color specification
- Bores for adapting tooling – customer specific sizes

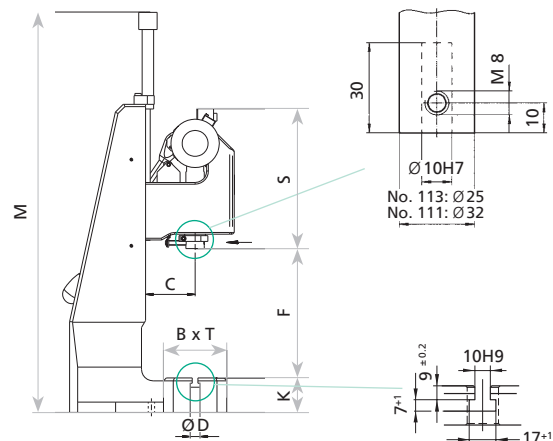
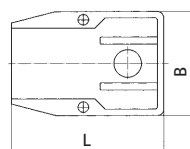

Detailed dimensional drawings can be downloaded: www.schmidttechnology.de

SCHMIDT® Toggle Presses with Square Ram

Optimum guidance and anti-rotation

Do you need a high force at the end of stroke for material-transforming processes? Then **SCHMIDT® Toggle Presses** are just the right choice.

Characteristics

- High force at the end of stroke
- Square ram is anti-rotational (no die sets required)
- Fully adjustable, play-free teflon-lined gibs



Press Type 11 VRZ
13 VRZ
14 VRZ

Press Type 15 VF
16 VF

Press Type 19 VF

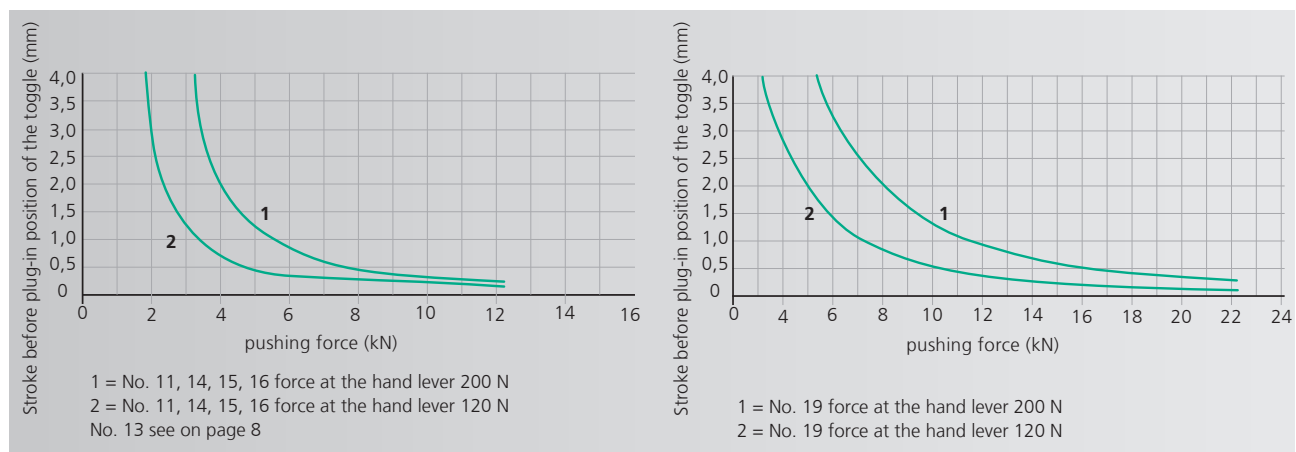

Maximum force will be reached just before extended position

From 5 kN to 22 kN

Press Type		13 V 13 VF	13 VR 13 VRF	11 V 11 VF	15 V 15 VF	11 VR 11 VRF	15 VR 15 VRF	14 V 14 VF	16 V 16 VF	14 VR 14 VRF	16 VR 16 VRF	19 V 19 VF	19 VR 19 VRF
Press head type		13V-40 13VF-40	13VR-40 13VRF-40	11V-45 11VF-45	11V-45 11VF-45	11VR-45 11VRF-45	11VR-45 11VRF-45	11V-60 11VF-60	11V-60 11VF-60	11VR-60 11VRF-60	11VR-60 11VRF-60	19V-40 ¹⁾	19VR-40 ¹⁾
Nominal force	kN	5	5	12	12	12	12	12	12	12	12	22	22
Working stroke up to ⁵⁾	A mm	40 40	40 40	45 45	45 45	45 45	45 45	60 60	60 60	60 60	60 60	40 40	40 40
Throat depth	C mm	65	65	86	86	86	86	86	86	86	86	131	131
Press head height	S mm	385 400	385 400	510 530	510 530	510 530	510 530	510 530	510 530	510 530	510 530	620 620	620 620
Ram bore	Ø mm	10H7	10H7	10H7	10H7	10H7	10H7	10H7	10H7	10H7	10H7	20H7	20H7
Hand lever left		○		○	○			○	○			●	●
Angle of rotation		95°	95°	110°	110°	110°	110°	125°	125°	125°	125°	175°	175°
Max. weight upper tool ³⁾ standard / reinforced spring	kg	1.2/4 2/3.5	1.2/4 2/3.5	1.6/4.2 2/5	1.6/4.2 2/5	1.6/4.2 2/5	1.6/4.2 2/5	1/3.5 1/3.5	1/3.5 1/3.5	1/3.5 1/3.5	1/3.5 1/3.5	2/- 2/-	2/- 2/-
Return stroke lock ²⁾													
Minimum working stroke	mm		26			20	20			28	28		10
Locked position 1	mm bef. BDC		14.5			12	12			14	14		4.5
Locked position 2	mm bef. BDC		1.5			1.5	1.5			1.5	1.5		0.9
Disengaging accuracy	mm		0.03			0.03	0.03			0.04	0.04		0.02
Working height ⁴⁾	F												
Frame No. 13	mm	65-180 50-165	65-180 50-165										
Frame No. 3	mm			80-210 60-190		80-210 60-190		80-210 60-190		80-210 60-190			
Frame No. 2	mm				105-350 85-330		105-350 85-330		105-350 85-330		105-350 85-330		
Frame No. 2-600 ○	mm				200-585 185-570		200-585 185-570		210-590 195-575		210-590 195-575		
Frame No. 2-1000 ○	mm				330-1020 315-1000		330-1020 315-1000		340-1030 325-1015		340-1030 325-1015		
Frame No. 19	mm											90-220	90-220
Frame No. 19-400 ○	mm											160-400	160-400
Frame No. 19-500 ○	mm											260-550	260-550
Weight	approx. kg	12	12	24	32	24	32	24	32	24	32	85	85
Accessories		13 V 13 VF	13 VR 13 VRF	11 V 11 VF	15 V 15 VF	11 VR 11 VRF	15 VR 15 VRF	14 V 14 VF	16 V 16 VF	14 VR 14 VRF	16 VR 16 VRF	19 V 19 VF	19 VR 19 VRF
Mechanical counter		○	○	○	○	○	○	○	○	○	○	○	○
Throat depth frame 111 mm, 131 mm				○	○	○	○	○	○	○	○		
Throat depth frame 151 mm												○	○
Additional fixture mounting plate suitable for throat depth frame				○	○	○	○	○	○	○	○	○	○
Frame Overview		Press Type	Frame Height M (mm)	Table Size B x T (mm)	Table Bore D (Ø mm)	Table Height K (mm)	Mounting Surface B x L (mm)						
No. 13		13	475	110 x 80	20H7	46	110 x 85						
No. 3		11, 14	540	150 x 110	20H7	60	150 x 260						
No. 2		15, 16	700	185 x 110	20H7	60	185 x 280						
No. 2-600 ○		15, 16	974	200 x 160	20H7	98	200 x 290						
No. 2-1000 ○		15, 16	1410	200 x 160	20H7	98	200 x 290						
No. 19		19	640	200 x 160	25H7	112	200 x 370						
No. 19-400 ○		19	840	250 x 200	40H7	145	250 x 460						
No. 19-500 ○		19	1000	250 x 200	40H7	145	250 x 480						

Options

- Series with no additional charge ○ Additional charge applies

¹⁾ Special strokes 12 mm and 50 mm on request

²⁾ Adjustment of locking position on request

³⁾ The weight was determined with hand lever position 45° forward (guide)

⁴⁾ Typical values; can vary ± 3 mm due to casting and production tolerances

⁵⁾ Stroke adjustable with stop clamp (in the scope of delivery)

⁶⁾ Adjustable stroke

Other available options

- Nickel plated – cast parts are electroless nickel plated, steel components black oxide finished, aluminum anodized, precision steel surfaces are untreated
- Custom Paint – Press and column can be painted to customer's color specification
- Bores for adapting tooling – customer specific sizes

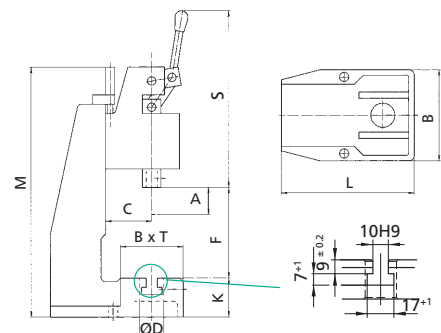

Detailed dimensional drawings can be downloaded: www.schmidttechnology.de

SCHMIDT® CamPress 11N

The best of both worlds

We have merged the best features of the two hand lever press types, the toggle press and the rack and pinion press, and combined them in the **SCHMIDT® CamPress 11N**. Thanks to this clever mechanism, the patented assembly press is characterized by a particularly smooth operation and strong force at the end of the stroke. The sophisticated mechanics make the manual CamPress 11N particularly ergonomic and user-friendly.

This unique motion creates a high, linear force progression with high breakaway torque at the beginning of the ram movement and a steep force increase at the end of the stroke; and all this with constant hand force.

The use of the balance weights and the ErgoHandle ensures a smooth motion process and ergonomic operation of the hand lever. Both components and height adjustment with the crank lever are part of the standard scope of delivery. Of course, the proven options such as return stroke lock, fine adjustment and mechanical counter can also be used here.

SCHMIDT® CamPress 11N
with return stroke lock and
fine adjustment



Balance weight and
ErgoHandle for
ergonomic operation
of the hand lever

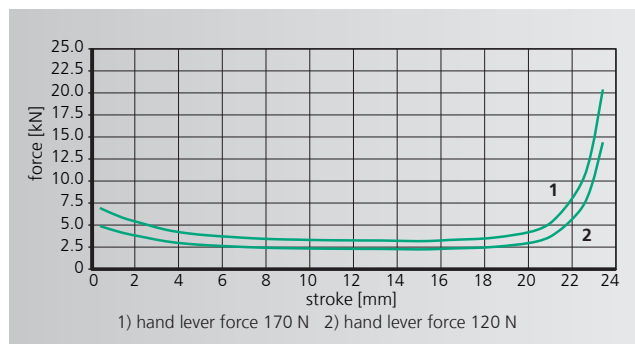

SCHMIDT® CamPress 11N

Examples of process-safe workstations

Press Typ		11N	11NF
Press head type		11N-23	11NF-23
Nominal force	kN	20	
Working stroke up to	A mm	23	23
Throat	C mm	86	
Head height	S mm	458	481
Ram bore	Ø mm	10H7	
Hand level left			
Rotation angle / stroke	°	180	
Max. weight upper tool ³⁾	kg	2	
Return stroke lock²⁾			
Minimum working stroke	mm	10.3	
Locked position 1	mm bef. BDC	12.7	
Locked position 2	mm bef. BDC	1.8	
Disengaging accuracy	mm	0.05	
Working height⁴⁾		F	
Frame No 5	mm	75 – 320	55 – 300
Weight	~ kg	40	

Option		11N	11NF
Mechanical counter		o	

Frame	Press Typ	Frame height M (mm)	Table size B x T (mm)	Table bore D (Ø mm)	Table height K (mm)	Footprint B x L (mm)
No. 5	11N	587	185 x 110	20 ^{H7}	60	185 x 273

Options

- Series with no additional charge o Additional charge applies
- ²⁾ Adjustment of locking position on request
- ³⁾ The weight was determined with hand lever position 45° forward (guide)
- ⁴⁾ Typical values; can vary ± 3 mm due to casting and production tolerances

Other available options

- Nickel plated – cast parts are electroless nickel plated, steel components black oxide finished, aluminum anodized, precision steel surfaces are untreated
- Custom paint – press and column can be painted to customer's color specification
- Bores for adapting tooling – customer specific sizes

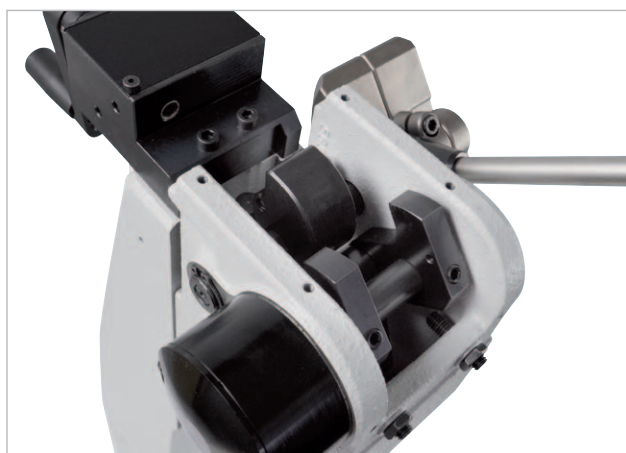

Patented mechanics with high force at the end of the stroke

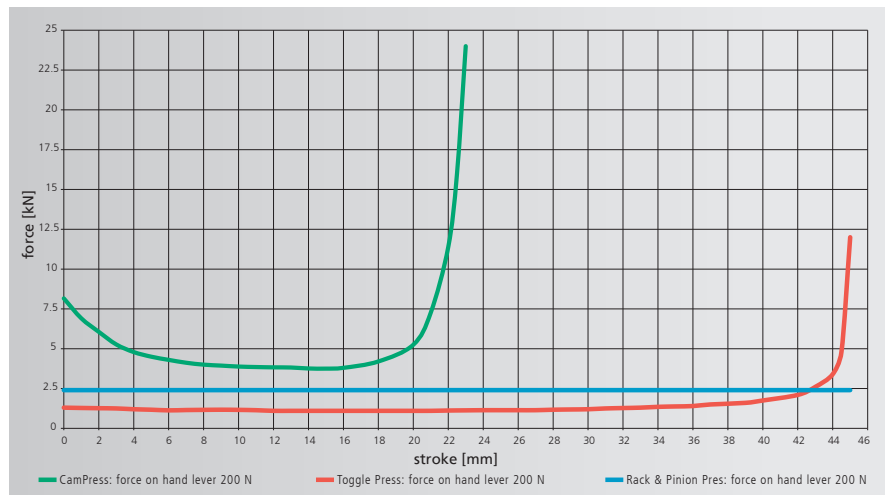

CamPress 11N in comparison to Toggle Press and Rack and Pinion Press

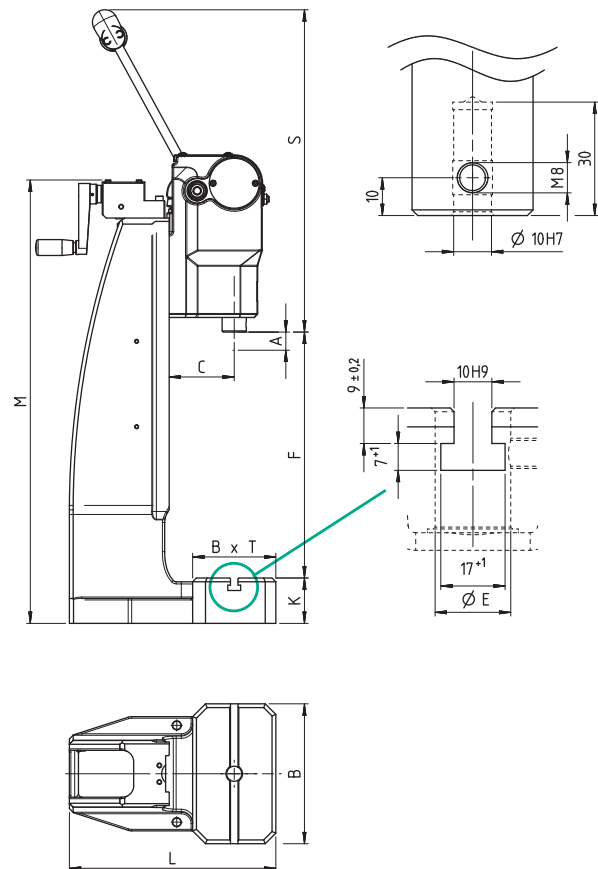

SCHMIDT® DuplexPress 8

With minimal effort of 0,12 kN a high force of 7 kN

The **SCHMIDT®** DuplexPress 8 breaks new ground for familiar hand lever presses with a completely new operating principle. The challenge of achieving high forces (7 kN) with long strokes (up to 140 mm) is not possible either with conventional rack and pinion or toggle presses. Thus this new developed press represents a very universal solution for pressing tasks, which can also be used extremely ergonomically with low hand force (120 N).

The left hand lever actuates the approach stroke to position the ram quickly to the workpiece.

The right hand crank activates the power stroke any time with little manual force. The transmission ratio of the planetary gearbox achieves a high effective force on the ram. This is useful, for example, when a long stroke has to be covered before reaching the component where the high forces of the press are required.

Why compressed air?

Why does the press have a compressed air connection or an accumulator?

The compressed air retracts the ram back to the TDC (top dead center) with constant force and speed. In addition, the speed can be individually adjusted with the pressure regulator, this pneumatic driven return stroke increases the ergonomic compared to a conventional spring solution. In addition, the two-chamber design of the tank ensures that the weight of the upper tool can be compensated via the adjustable differential pressure.

The version with pressure tank is available for self-sufficient and maximum energy-efficient operation of the press. Thanks to the intelligent re-storage of compressed air, the loss of compressed air is minimised and it is sufficient to fill the tank about once a week. Alternatively, the press can also be connected directly to the compressed air supply.

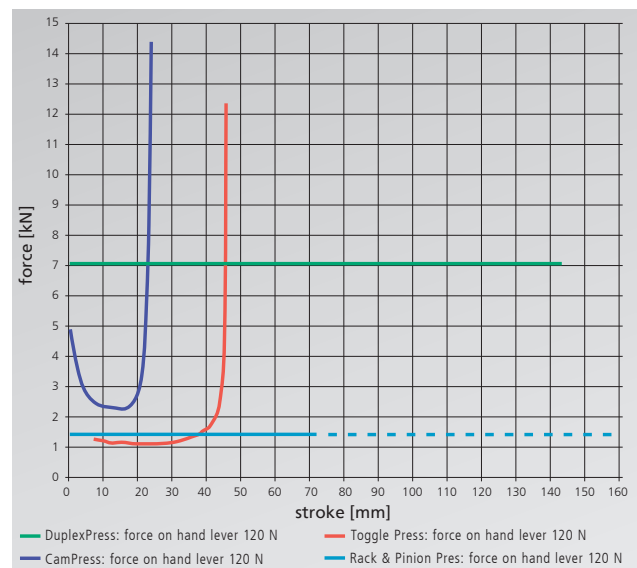

DuplexPress in comparison to Toggle Press, Rack and Pinion Press or CamPress 11N

SCHMIDT® DuplexPress 8

A long stroke of 140 mm and super ergonomic operation

Press Typ			8
Nominal force		kN	7
Working stroke	A	mm	140
Throat	C	mm	86
Head height	S	mm	446
Ram bore	Ø	mm	10 ^{H7}
Max. force at crank (power stroke)		N	120
Max. weight upper tool ²⁾		kg	5
Working height ⁴⁾	F	mm	35 – 285
Height adjustment			series
Head weight 8RDS		approx. kg	19.5
Mechanical counter			series
Return stroke lock for 8R, 8RD, 8RS, 8RDS ²⁾			
Minimum working stroke		mm	120.4
Locked position 1 (bef. BDC)		mm	19.6
Locked position 2 (bef. BDC)		mm	6.8
Disengaging accuracy		mm	± 0.04
Max. operating pressure			
Network operation		bar	6
Storage module (self-sufficient operation)		bar	8

Frame	Frame height M (mm)	Table size B x T (mm)	Table bore D (Ø mm)	Table height K (mm)	Footprint B x L (mm)	Weight kg
No. 5	536	110 x 80	20 ^{H7}	60	110 x 185	26
No. 2-600	974	200 x 160	20 ^{H7}	98	200 x 290	52

²⁾ Adjustment of locking position on request

⁴⁾ Typical values; can vary ± 3 mm due to casting and production tolerances

Other available options

- Custom paint – press and column can be painted to customer's color specification
- Bores for adapting tooling – customer specific sizes



DuplexPress 8R(S)



DuplexPress 8D(S)



DuplexPress 8RD(S)



DuplexPress 8

Nomenclature

- R = Return stroke lock
- D = Duplex (rapid approach stroke)
- S = Storage module (self-sufficient operation)



DuplexPress 8S

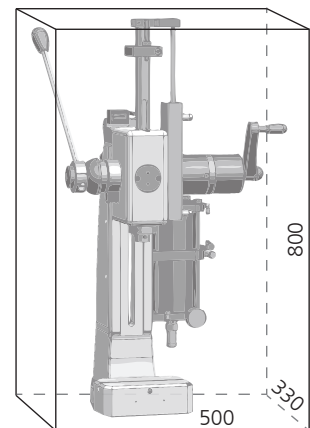

Volume dimensions with frame no. 5

SCHMIDT® ManualPress

Options suitable for your application

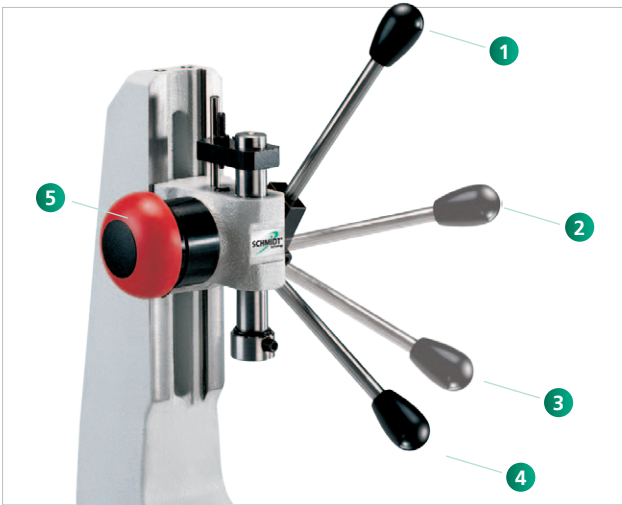

The return stroke lock guarantees reaching the required pressing depth with every stroke

- 1 TDC (Top Dead Center) position
- 2 First locking position: Loose tools can still be aligned
- 3 Second locking position before BDC (Bottom Dead Center). From here you can only continue to BDC.
- 4 After reaching BDC (Bottom Dead Center) and completing the stroke the return stroke lock is released. This guarantees a repeatable BDC and thus a constant press depth
- 5 The emergency button releases the locking function in any position



Fine adjustment with micrometer scale serves as stop for the rack and pinion presses

An optional micrometer adjustable stop developed specifically for applications that need fine adjustment of the BDC. The robust and precise design ensures the repeatability of the stop, no matter how many strokes are taken.

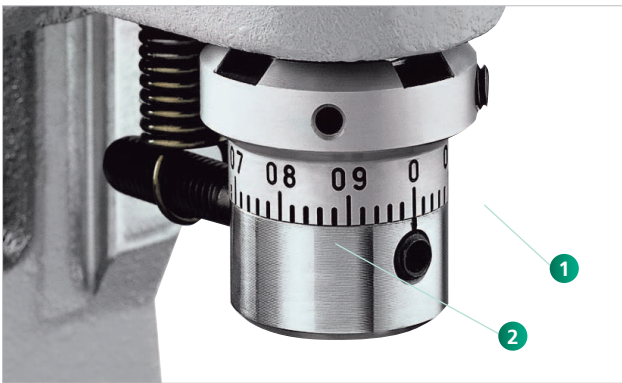

Fine adjustment with micrometer scale for toggle presses

By loosening the set screw 1 and turning the adjusting nut 2 with the same tool, the setting of the BDC can be adjusted infinitely. The adjustment in a range of $\frac{1}{100}$ of a mm is reached rapidly and precisely.

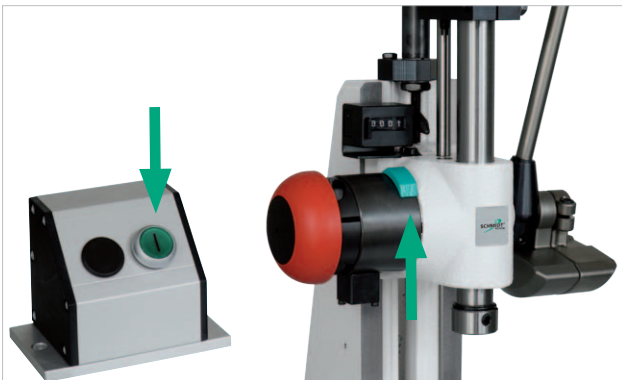

Stroke-Release Manual Presses – for more Safety

Monotonous, manually operated press applications can potentially become a source of danger with serious injuries.

The remedy is to equip our manual presses with clever mechanics. This turns them into safety devices with 2-hand operation for ram movement.

The stroke release is achieved by disengaging the locking mechanism with one hand; now the 2nd hand can operate the hand lever. Alternatively, the locking mechanism can be unlocked by a button.

SCHMIDT® ManualPress

Options suitable for your application



Mechanical counter

A four digit counter monitors the number of pieces produced. The counter is provided with a reset function.



Collet

For the rack-and-pinion presses No. 1 and No. 2, collet bore diameter of 1 to 17 mm.



Throat extension block

We offer various sizes for extended throat depths.



Special fixture mounting plates

Special fixture tabletops, designed in conjunction with throat extension blocks, provide ram to table bore alignment when spacer is used.



Ergonomic left-handed design

With most press types, lefthanded or left-/right-handed design is an available option.

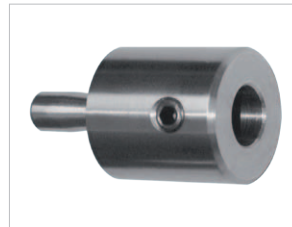

Upper tooling adapter

Adapter for tools with a diameter of 5 - 20 mm.



Nickel plated design

Press frames and cast parts are electroless nickel-plated, steel components are black oxide finished, aluminum parts are anodized, precision steel surfaces are untreated.



Ergonomic handle

Swivelling handle for improved comfort; easy and flexible assembly on the hand lever.



Press base

Plastic (250 x 340 mm), including fasteners.



Stop clamp

For Toggle Presses.



PartProtector Quick-Change Tool Adapter (QTA)

The tool adapter is secured in the adapter base without any tools. A cylindrical pin helps to position and guide the tool adapter.



This is a force-limiting tool adapter.

The maximum force applied to the parts and the travel required to accommodate varying part heights are predetermined by a combination of flat and beveled washers installed in the tool holder. This is particularly beneficial with hard-stop tooling solutions or toggle presses. Adjustable force range: 0.6 – 12 kN

SCHMIDT® ManualPress 300 Series

Manual Presses with Process Monitoring

Process reliability, force/stroke monitoring of the joining process and EN ISO-compatible documentation of the results are becoming the major factors for small and medium production within the manual workplace.

Process reliability – not just a slogan

The system software allows easy setup of quality control criteria for 100 % in-process monitoring.

The **SCHMIDT® ManualPress 300 Series** system with **SCHMIDT® PressControl 700** includes:

- Integrated reliable measuring technology
- High resolution of the obtained process data
- Graphical and numerical output of the processing results
- Quality monitoring using freely selectable tolerances



Assembly system with patented return stroke lock and programmable clutch.

SCHMIDT® ManualPress 300 Series

Process reliability for manual workplaces, force range 0.4 kN to 12 kN

Characteristics

- Linear force progression for No. 305 and No. 307
- High force at the end of stroke for No. 311
- Precise adjustment of the press depth via micrometer fine adjustment
- Guides require little maintenance, have little wear and are locked against rotation. This results in precise working and a long service life
- Optimum guidance and clamping due to dovetail guide on the press head
- Quick set-up
 - Exact alignment of ram bore to the table within 0.05 mm
 - Height adjustment using a crank
 - Precision bores in ram and column base plate

Functional components

- Electronic stroke lock
- Integrated transducer
 - Force sensor
 - Incremental encoder
- Integrated signal amplifier
- Programmable overload coupling

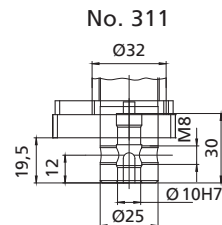
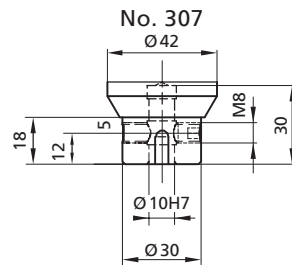
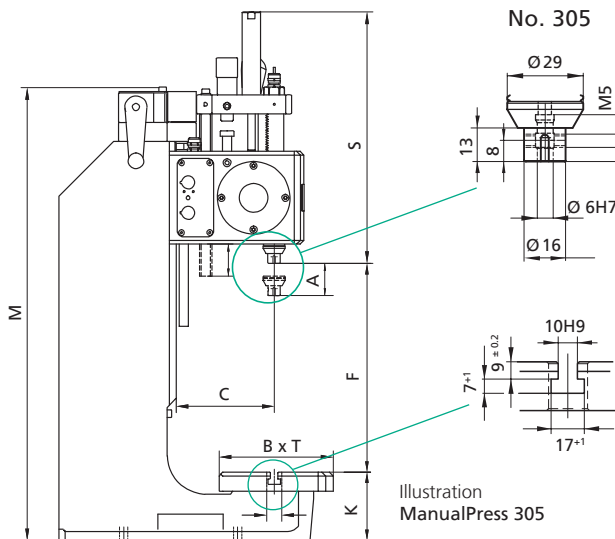
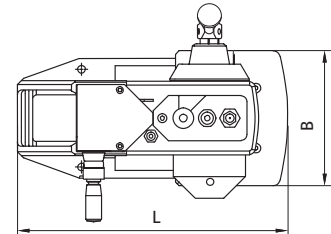

Press Type		305	307	311
Nominal force	kN	0.4	4	12
force at the hand lever	approx. N	50	200	200
Working stroke up to	A mm	42 ⁵⁾	54 ⁵⁾	50
Throat depth	C mm	129	129	129
Press head height	S mm	310	417	555
Ram bore	Ø mm	6H7	10H7	10H7
Stroke fine adjustment	mm	0.02	0.02	0.02
Stroke resolution	mm	0.005	0.005	0.005
Angle of rotation/mm stroke		3.3°	4.8°	non linear
Resolution, process data acquisition	stroke µm/inc force N/inc	5 0.125	5 1.25	5 3.5
Working height ⁴⁾	F			
Frame No. 7-420	mm	60-420	50-410	50-290
Frame No. 7-600 ²⁾	mm	90-600	80-600	80-480
Max. weight upper tool ³⁾	kg	0.6	1	1.3
Weight	approx. kg	41	41	60
Protection type		IP 54	IP 54	IP 54
Accessories				
Stronger return assist spring		○	○	
Speed control		○	○	
Throat depth frame ¹⁾ (total depth)		○	○	
		169, 209, 249 mm		

ManualPress 311

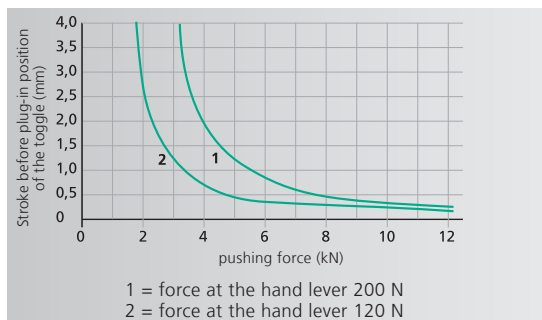

Maximum force will be reached just before extended position

Frame Overview	Press Type	Frame Height M (mm)	Table Size B x T (mm)	Table bore D Ø mm	Table Height K (mm)	Mounting Surface B x L (mm)
No. 7-420	305, 307, 311	740	180 x 150	20H7	90	220 x 362
No. 7-600 ○	305, 307, 311	960	180 x 280	20H7	110	220 x 465

Options

- Additional charge applies
- ¹⁾ Throat depth frame only available with frame No. 7-600
- ²⁾ Increased throat and higher frame lead to smaller nominal forces for No. 311
- ³⁾ The weight was determined with hand lever position 45° forward (guide)
- ⁴⁾ Typical values; can vary ± 3 mm due to casting and production tolerances
- ⁵⁾ Adjustable stroke

Other available Options:

- Nickel plated – cast parts are electroless nickel plated, steel components black oxide finished, aluminum anodized, precision steel surfaces are untreated
- Custom paint – press and column can be painted to customer's color specification
- Bores for adapting tooling – customer specific sizes can be supplied

SCHMIDT® ManualPress 300 Series

Options suitable for your application



Control mounting bracket

Used for fastening the **SCHMIDT® PressControl 700**, either mounted to the table or to the wall. The mounting bracket permits the unit to pivot 70° (included with control).



External reset button

We recommend an external reset button in rough production environments.



Calibration tool

The calibration tool is a device with which a constantly defined force is applied to the load cell of the **SCHMIDT® ManualPress Serie 300 Series**. In order to complete calibration, either a **SCHMIDT® LoadCheck** or a customer supplied calibration device is required. Photo on left side shows the device for the **SCHMIDT® ManualPress 305**. The right side is for **SCHMIDT® ManualPress 307**. The **SCHMIDT® ManualPress 311** is calibrated by using the fine adjustment mechanism in BDC.



EtherCAT Compact Box

8 digital channels, usable as inputs or outputs, signal connection by screwing via M8 plug connector, power supply (24 V) via EtherCAT-P, load currents of the outputs up to 0.5 A, total current of all outputs 3 A

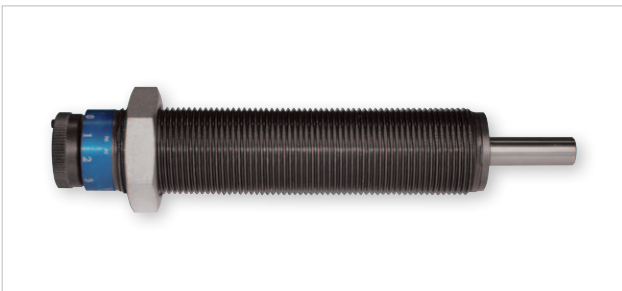

Speed control

To achieve a very high repeatability when pressing to a force or stroke, the optional speed control can be added to provide hydraulic resistance to the ram movement over a targeted length at the end of the stroke.



Ergonomic handle

Swivelling handle for improved comfort; easy and flexible assembly on the hand lever.



Press base

Plastic (250 x 340 mm), incl. fasteners.

SCHMIDT® PneumaticPress

Maximum pressing force from 1.6 kN to 60 kN

The **SCHMIDT® PneumaticPress** range builds on a modular concept and can generate up to 60 kN. They are ideally suited for joining, assembly and forming applications.

With the addition of the **SCHMIDT® PressControl 75** or **700** and the optional process monitoring, these presses become EC type-approved, CE-conformed workstations. Therefore these press systems can be used in either single cycle or automatic mode.

The application determines the selection of the press system. Consideration is given to the flexible design of the assembly location, taking into account the ergonomic and safety aspects. These characteristics are achieved by means of a finely adjusted, modular type product range. The efficiency and increased process reliability of these press systems have been proven many times, in single applications, semi-automated assembly systems and have been integrated into automated production lines.



SCHMIDT® PneumaticPress

Example of a system design with a direct acting press

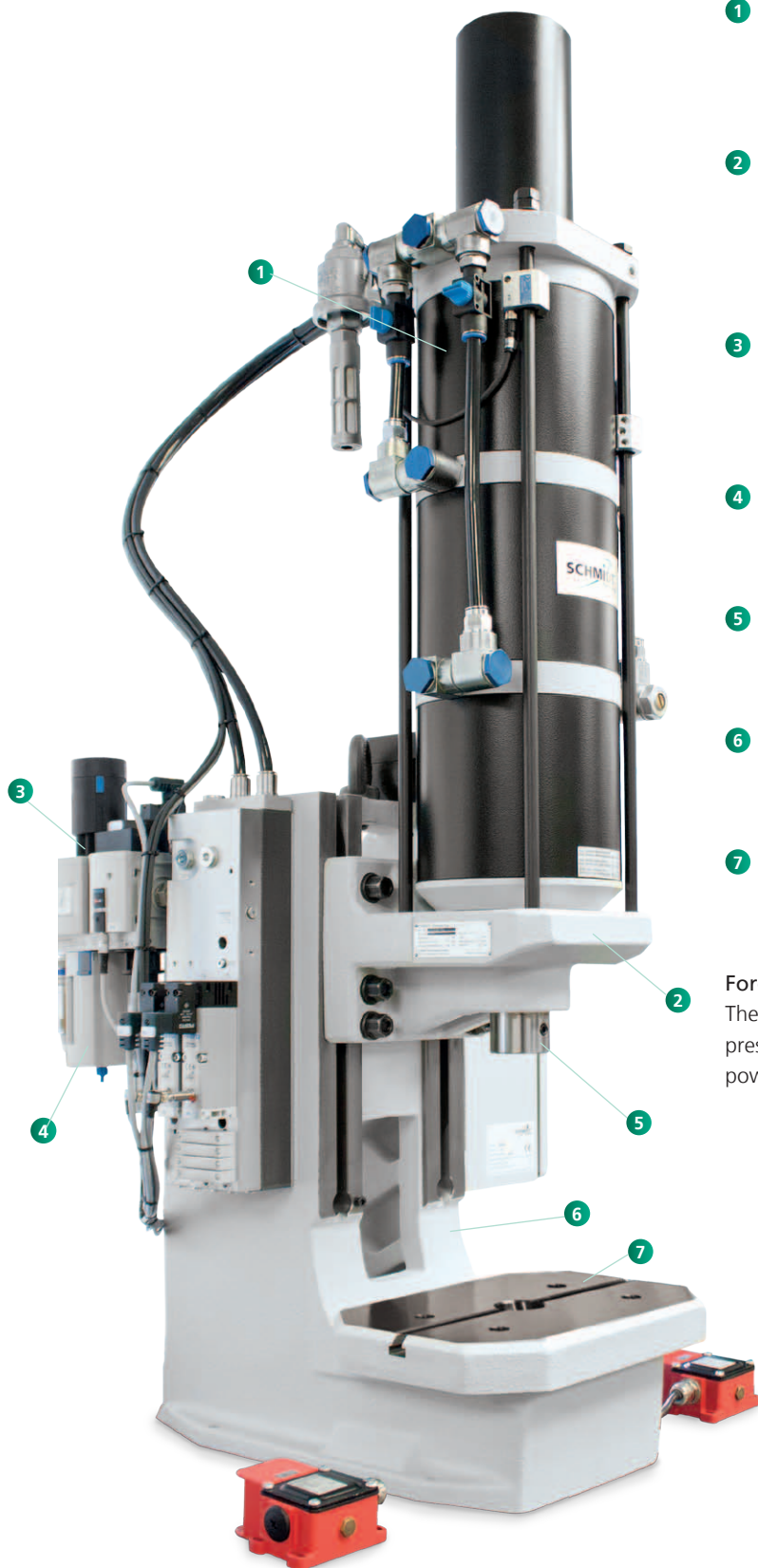

1 Cylinder unit

Maintenance-free specially developed for the assembly technology; with flow control for speed regulation of the down-stroke.

2 Press Head unit

Modular design allows for quick and accurate height adjustment when installed on our column or the system can be easily integrated, in any orientation, to an automated press solution.

3 Pneumatic control package

Two-channel pneumatic package (as shown) is based on a modular valve block, designed to operate with filtered, non-lubricated air, supply pressure range of 3 – 6 bar.

4 Force control

The force output can easily be controlled via a regulator and pressure gauge.

5 Ram

With precision bore for tool holding and built-in, adjustable stop.

6 Frame

Robust design with precision machined keyway for press head alignment.

7 Fixture mounting plate

With precision T-slot and precision bore for tool location.

Force output preselector (optional)

The press force output can easily be controlled via a separate pressure regulator and pressure gauge. The pressure for the power stroke can be reduced to 1 bar

SCHMIDT® PneumaticPress

Principle of operation

Functional description using a 3-chamber pneumatic cylinder – as an example.

In working stroke, three pistons **7** connected by the piston rod **6** are pressurized with compressed air via the air connection **1** and move downward. The air below the pistons exhausts from the cylinder chambers via the depressurized connection **2** and the breather vents **3** and **4**. The ram **5** extends up to the maximum working stroke.

In return stroke, the upper cylinder chambers are depressurized via the connection **1** and only the bottom piston is pressurized with compressed air via the air connection **2**. Ambient air enters in both remaining cylinder chambers via the breather vents **3** and **4**. The ram with the three pistons moves upward.

This construction has the same effect as a parallel connection of three cylinders. Thus, a powerful working stroke is achieved with a compact design as well as an economic use due to the low air consumption in the return stroke.

The stroke can be limited by setting the Stroke Limit Block **8** to an approximate, desired position. The gap between Stroke Limit Block and Stroke Fine Adjustment **9** now determines the maximum stroke that the ram can travel. In order to fine-tune this stroke, fine adjustment nut **9** can be adjusted.

All direct acting presses have a built-in permanent magnet **10**. This magnet facilitates sensing of the ram position via tie rod mounted sensors.

Characteristics

- Optimally adapted to individual requirements due to its modular design
- Process optimization by means of adjustable parameters (stroke, force, speed)
- Easy adaptation to different tool and part heights because of simplistic stroke and height adjustment
- Additional safety measures when using heavy tools due to the optional device for retention of ram in home position
- End position control via cylinder switches as signal transmitter for peripheral processes
- Low noise level (< 75 dBA)
- Double-acting, wear-resistant cylinders with low air consumption for the return stroke
- High flexibility due to short changeover time
- Long service life and high precision due to wear-resistant Teflon coated bushings at top and bottom of cylinder
- Precision ground ram
- Precision double ram guides

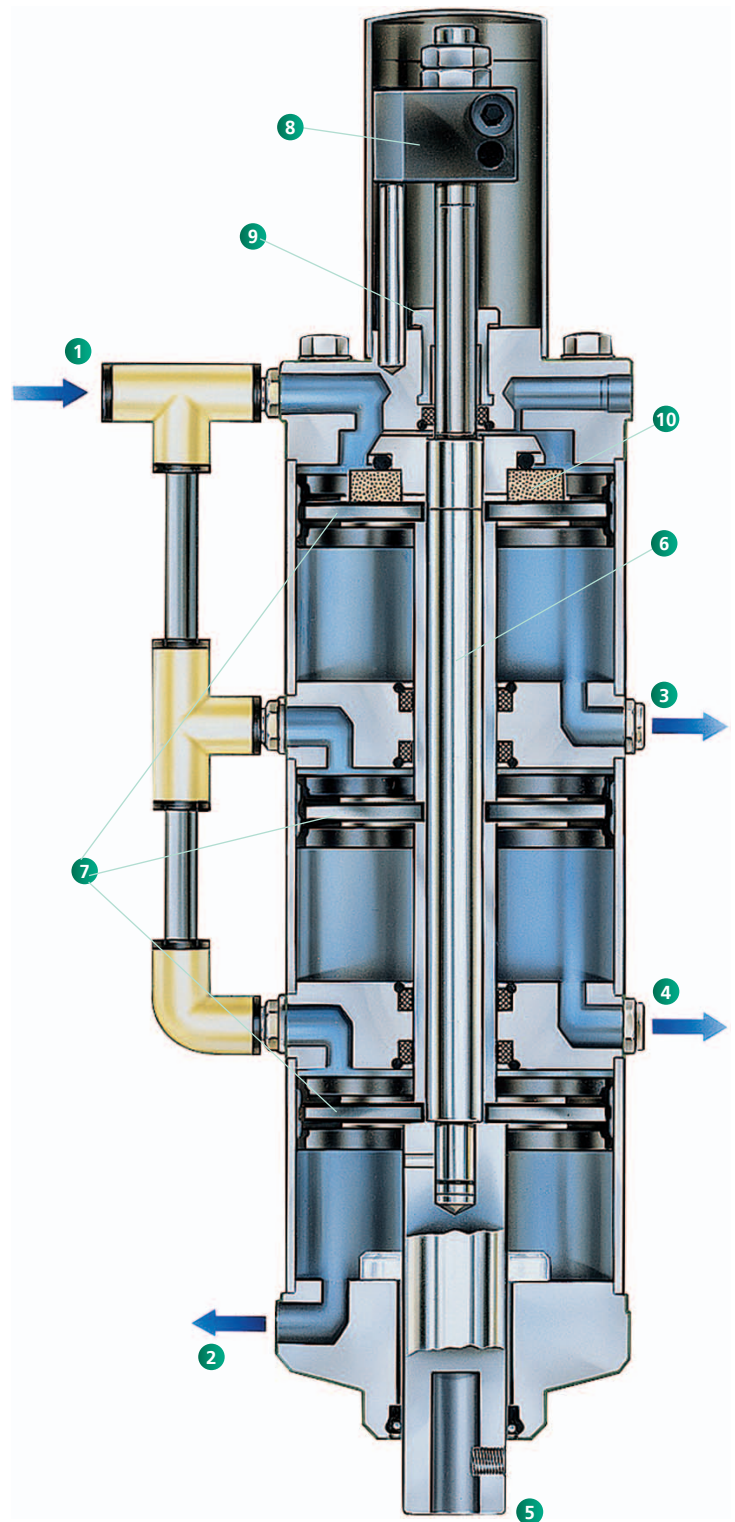

SCHMIDT® PneumaticPress

Direct acting with constant force over the entire stroke

Characteristics

- Round anti-rotational ram
- Adjustable ram position in BDC by means of precision lower stop (1 division line = 0.05 mm) on scale
- T-slot with locking set screw in fixture mounting plate



Press Type 20



Press Type 23

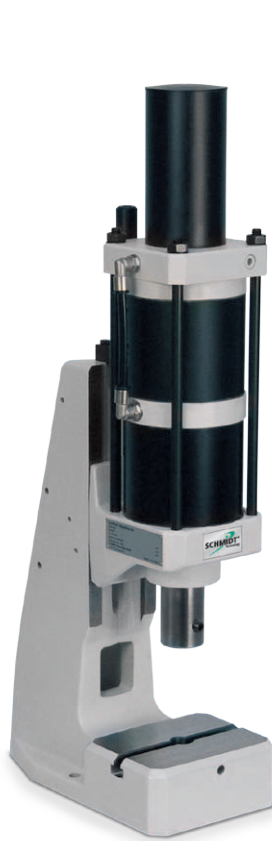

Press Type 24



Press Type 25



Pneumatic cylinder with piston and magnet kit for ram position via cylinder switch.

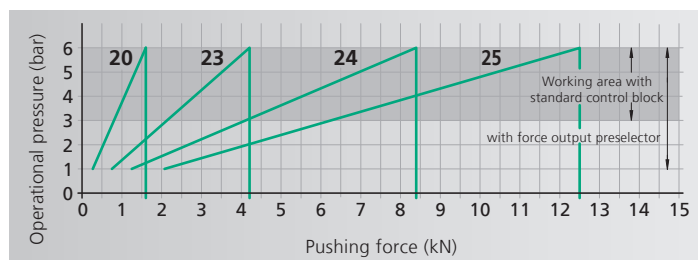

From 1.6 kN to 12.5 kN

Press Type			20	23	24	25
Working stroke up to	A	mm	50, 75 100, 125 160, 200 250, 300	50, 75 100, 125 160, 200 250, 300	50, 75 100, 125 160	50, 75 100
Nominal force at 6 bar		kN	1.6	4.2	8.4	12.5
Throat depth	C	mm	86	86	86	86
Throat depth frame \varnothing		mm	111, 131 160, 200	111, 131 160, 200	111, 131 160, 200	111, 131
Additional fixture mounting plate suitable for throat depth frame			\varnothing	\varnothing	\varnothing	\varnothing
Ram bore	\varnothing	mm	20H7	20H7	20H7	20H7
Ram diameter	\varnothing	mm	40	40	40	40
Working height ¹⁾	F					
Frame No. 3		mm	80-220	90-210	90-210	90-210
Frame No. 2 \varnothing		mm	110-360	120-350	120-350	120-350
Frame No. 2-600 \varnothing		mm	200-600	210-580	210-580	210-580
Frame No. 2-1000 \varnothing		mm	330-1040	335-1020	335-1020	335-1020
Weight		approx. kg	30	35	40	45
Flange model			20-FL	23-FL	24-FL	25-FL
Cylinder	Z	\varnothing mm	69	106	106	106
Flange	FL	\varnothing mm	110	140	140	140
Width across flats	SW	mm	80	112	112	112
Centering shoulder	ZA	\varnothing mm	60	68	68	68

Frame Overview	Press Type	Frame Height M (mm)	Table Size B x T (mm)	Table Bore D \varnothing mm	Table Height K (mm)	Mounting Surface B x L (mm)
No. 3	20, 23, 24, 25	540	150 x 110	20H7	60	150 x 260
No. 2	20, 23, 24, 25	700	185 x 110	20H7	60	185 x 280
No. 2-600 \varnothing	20, 23, 24, 25	974	200 x 160	20H7	98	200 x 290
No. 2-1000 \varnothing	20, 23, 24, 25	1410	200 x 160	20H7	98	200 x 290

Options

\varnothing Additional charge applies

¹⁾ Typical values; can vary ± 3 mm due to casting and production tolerances

Other available options

- Nickel plated – cast parts are electroless nickel plated, steel components black oxide finished, aluminum anodized, precision steel surfaces are untreated
- Custom Paint – press and column can be painted to customer's color specification
- Bores for adapting tooling – customer specific sizes can be supplied

Bottom View of the Press Head, Flange Model

Mounting drill pattern flange/ram

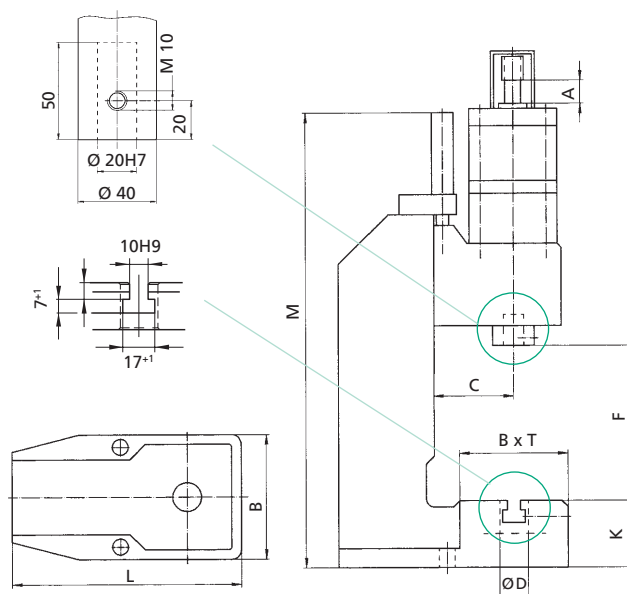
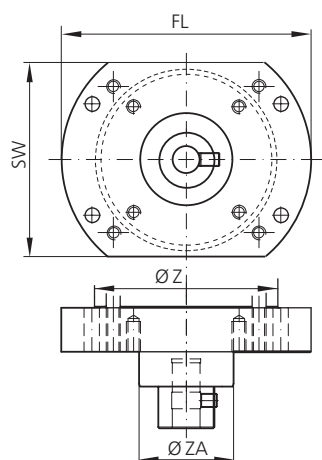

Detailed dimensional drawings can be downloaded:
www.schmidttechnology.com

SCHMIDT® PneumaticPress

Direct acting with constant force over the entire stroke

Characteristics

- Round anti-rotational ram
- Adjustable ram position in BDC by means of precision lower stop (1 division line = 0.05 mm) on scale



Press Type 27



Press Type 29



Precision lower stop

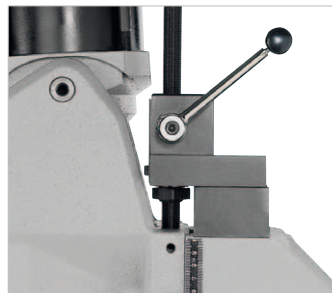

Height adjustment
Fast, accurate setting of the work height.

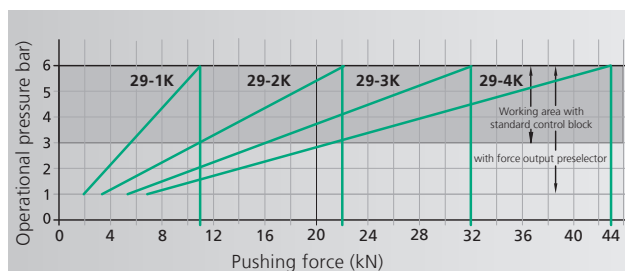
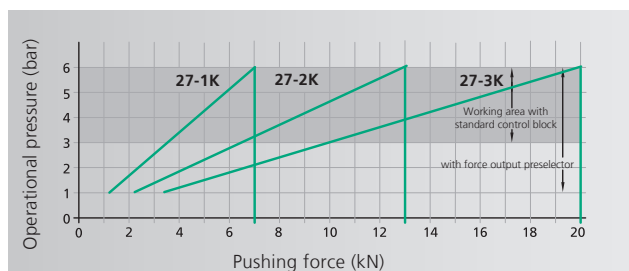

From 7 kN to 43 kN

Press Type			27-1K	27-2K	27-3K	29-1K	29-2K	29-3K	29-4K
Working stroke up to	A	mm	50, 75, 100	50, 75	50, 75	50, 75	50, 75	50, 75	50, 75
			160, 200	100, 125	100, 125	100, 160	100, 125	100, 125	100, 125
			250, 300	160, 200	160	200, 300	160, 200	160	100
Nominal force at 6 bar		kN	7	13	20	11	22	32	43
Throat depth	C	mm	131	131	131	140	140	140	140
Throat depth frame \circ		mm	151	151	151	160, 185	160, 185	160, 185	160
Additional fixture mounting plate suitable for throat depth frame			\circ	\circ	\circ	\circ	\circ	\circ	\circ
Ram bore	\emptyset	mm	20H7	20H7	20H7	20H7	20H7	20H7	20H7
Ram diameter	\emptyset	mm	40	40	40	50	50	50	50
Working height ¹⁾									
Frame No. 34		mm	90-270	90-270	90-270				
Frame No. 301 \circ		mm	160-400	160-400	160-400				
Frame No. 301-500 \circ		mm	310-550	310-550	310-550				
Frame No. 29		mm				80-290	80-290	80-290	80-290
Frame No. 29-500 \circ		mm				150-500	150-500	150-500	150-500
Frame No. 29-600 \circ		mm				250-600	250-600	250-600	250-600
Weight (standard)		approx. kg	85	85	85	120	120	120	120
Flange model			27-1K-FL	27-2K-FL	27-3K-FL	29-1K-FL	29-2K-FL	29-3K-FL	29-4K-FL
Cylinder	Z	\emptyset mm	132	132	132	170	170	170	170
Flange	FL	\emptyset mm	180	180	180	220	220	220	220
Width across flats	SW	mm	140	140	140	180	180	180	180
Centering shoulder	ZA	\emptyset mm	68	68	68	80	80	80	80

Frame Overview	Press Type	Frame Height M (mm)	Table Size B x T (mm)	Table Bore D \emptyset mm	Table Height K (mm)	Mounting Surface B x L (mm)
No. 34	27	630	200 x 160	25H7	111	200 x 370
No. 301	27	830	250 x 200	40H7	145	250 x 460
Frame No. 301-500 \circ	27	990	250 x 200	40H7	145	250 x 480
Special fixture mounting plate with 3 longitudinal slots \circ			300 x 220 400 x 230	40H7 40H7		
Frame No. 29	29	690	300 x 220	40H7	141	300 x 460
Frame No. 29-500 \circ	29	990	300 x 220	40H7	166	300 x 540
Frame No. 29-600 \circ	29	1110	300 x 220	40H7	166	300 x 565
Special fixture mounting plate with 3 longitudinal slots \circ			355 x 225 400 x 230	40H7 40H7		

¹⁾ Typical values; can vary ± 3 mm due to casting and production tolerances

Options

\circ Additional charge applies

Other available options

- Nickel plated – cast parts are electroless nickel plated, steel components black oxide finished, aluminum anodized, precision steel surfaces are untreated
- Custom Paint – press and column can be painted to customer's color specification
- Bores for adapting tooling – customer specific sizes can be supplied

Detailed dimensional drawings can be downloaded:
www.schmidttechnology.com

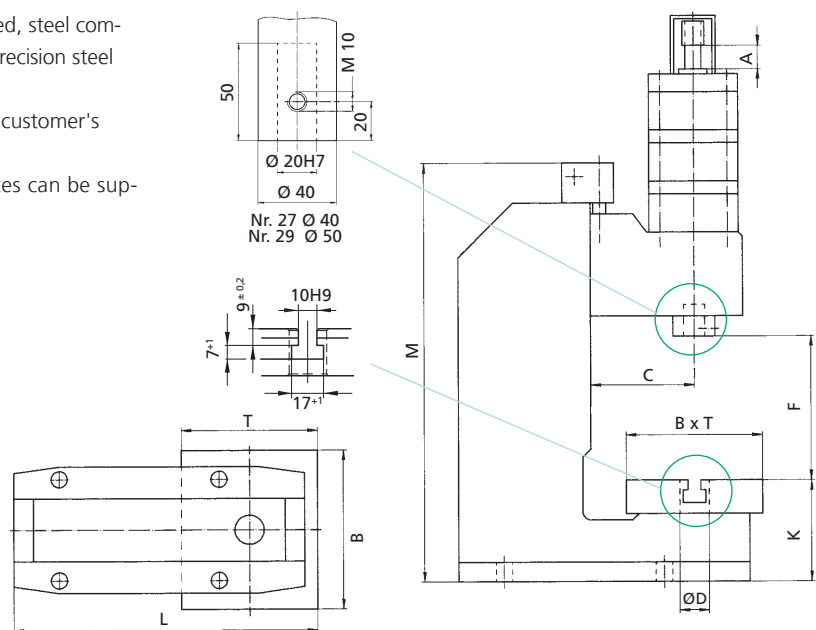
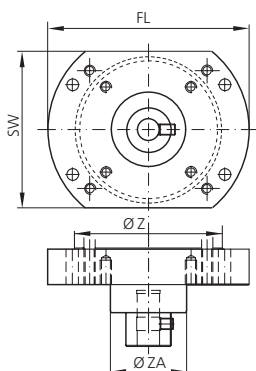

SCHMIDT® PneumaticPress

Pneumatic Toggle Presses with maximum force at the end of stroke

Characteristics

- Cross hole with locking screw in the press table for safe fixture of tool
- Accurate adjustable ram position via fine adjustment (type 33)
- T-slot with set screw in fixture mounting plate to secure bottom tool



Press Type 32



Press Type 33



Fine adjustment
for press No. 33 with scale
1 division line = 0.02 mm.



Flexible stroke adjustment
reduces the air consumption
for shorter strokes.

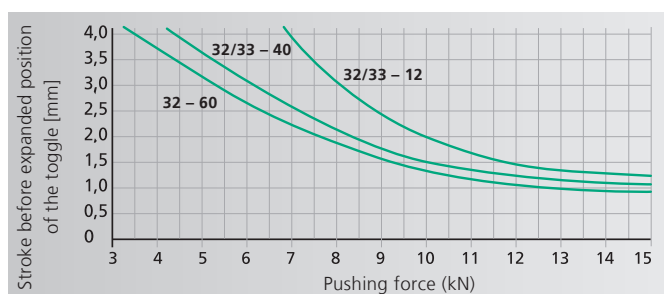

Up to 15 kN

Press Type			32	33
Working stroke up to	A	mm	0-12 4-40 6-60	0-12 4-40
Nominal force at 6 bar		kN	15	15
Throat depth	C	mm	86	86
Throat depth frame \circ		mm	111, 131	111, 131
Additional fixture mounting plate suitable for throat depth frame			\circ	\circ
Ram bore	\emptyset	mm	20H7	20H7
External ram dimensions	\emptyset	mm	40	40
Fine adjustment				•
Working height ¹⁾	F			
Frame No. 3 \circ		mm	80 – 205	
Frame No. 5		mm	80 – 350	35 – 295
Frame No. 2-600 \circ		mm	200 – 575	155 – 520
Frame No. 2-1000 \circ		mm	330 – 1020	285 – 965
Weight		approx. kg	45	50

Frame Overview	Press Type	Frame Height M (mm)	Table Size B x T (mm)	Table Bore D \emptyset (mm)	Table Height K (mm)	Mounting Surface B x L (mm)
No. 3	32	540	150 x 110	20H7	60	150 x 260
No. 5	32, 33	536	185 x 110	20H7	60	185 x 280
Frame No. 2-600 \circ	32, 33	810	200 x 160	20H7	98	200 x 290
Frame No. 2-1000 \circ	32, 33	1248	200 x 160	20H7	98	200 x 290

Options

- Series standard with no additional charge
- \circ Additional charge may apply
- ¹⁾ Typical values; can vary ± 3 mm due to casting and production tolerances

Other available options

- Nickel plated – cast parts are electroless nickel plated, steel components black oxide finished, aluminum anodized, precision steel surfaces are untreated
- Custom Paint – press and column can be painted to customer's color specification
- Bores for adapting tooling – customer specific sizes can be supplied

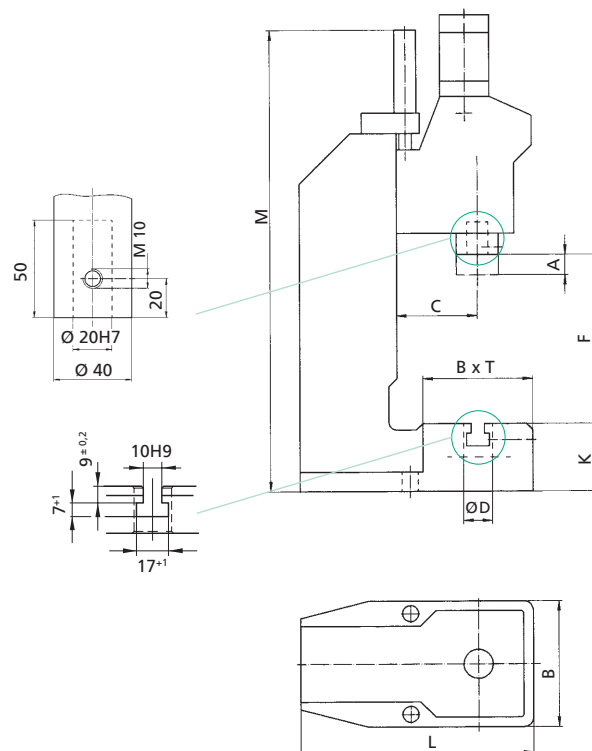

Detailed dimensional drawings can be downloaded:
www.schmidttechnology.com

SCHMIDT® PneumaticPress

Pneumatic Toggle Presses with maximum force at the end of stroke

Characteristics

- Anti-rotational square ram with fully adjustable, Teflon lined gibs for precise travel, no die set required
- Exact positioning due to fine adjustment scale (1 division line = 0.05 mm)



Press Type 34



Press Type 36

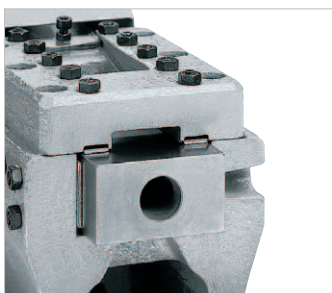

Square ram



Fine adjustment

Pushing Force Diagram

Operational pressure: 6 bar

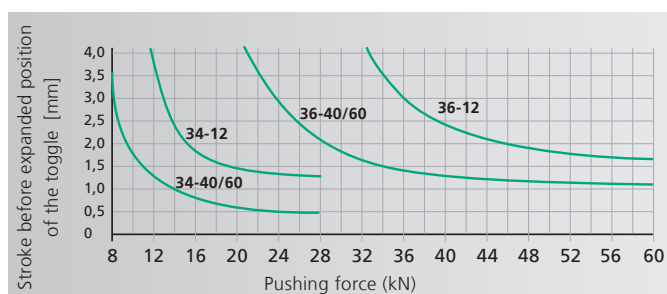

SCHMIDT® PneumaticPress

Direct acting Pneumatic Presses with force/stroke monitoring

SCHMIDT® PneumaticPresses with force/stroke monitoring are offered as complete systems with the SCHMIDT® PressControl 700 and 7000. These systems are characterized by sensors and signal amplification integrated in the press head. These signals are evaluated in real time.

Characteristics

- Direct forces are measured due to the force sensor integrated in the ram. Insensitive against side loads
- Force and displacement sensors are immune to EMI and environmental contamination
- A measuring data amplification integrated in the press head provides short transmission paths of unamplified signals
- Anti-rotational square ram with two fully adjustable guiding gibs for precise work and for non-guided tools
- Weld constructed steel frames to minimize frame flex.



Press Type 327, 329

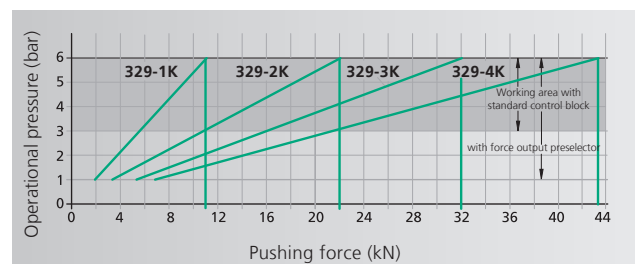

From 20 kN to 43 kN

Press Type			327-3K	329-2K	329-3K	329-4K
Working stroke up to	A	mm	50, 75, 100	50, 75, 100, 150	50, 75, 100, 125, 150	50, 75, 100
Nominal force at 6 bar		kN	20	22	32	43
Resolution, process data acquisition						
- stroke		µm/inc	5	5	5	5
- force		N/inc	6.25	6.25	10	12.5
Throat depth	C	mm	131	160	160	160
Throat depth frame ϕ		mm	151			
Fixture mounting plate suitable for throat depth frame		ϕ				
Ram bore	ϕ	mm	20 ^{H7}	20 ^{H7}	20 ^{H7}	20 ^{H7}
External ram dimensions	G x H	mm	70 x 50	90 x 60	90 x 60	90 x 60
Working height 1)	F					
Frame No. 301		mm	140 – 350			
Frame No. 301-500 ϕ		mm	310 – 500			
Frame No. 329		mm		130 – 300	130 – 300	130 – 300
Frame No. 329-460 ϕ		mm		190 – 460	190 – 460	190 – 460
Weight (standard)		approx. kg	170	320	325	330

Frame Overview	Press Type	Frame Height M (mm)	Table Size B x T (mm)	Table Bore D ϕ mm	Table Height K (mm)	Mounting Surface B x L (mm)
No. 301	327	830	250 x 200	40 ^{H7}	145	250 x 460
No. 301-500	327	990	250 x 200	40 ^{H7}	145	250 x 480
Special fixture mounting plate with 3 longitudinal slots ϕ			300 x 220 400 x 230	40 ^{H7}		
No. 329	329	810	300 x 230	40 ^{H7}	147	300 x 550
No. 329-460	329	990	300 x 230	40 ^{H7}	147	300 x 620
Special fixture mounting plate with 3 longitudinal slots ϕ			400 x 280 500 x 280	40 ^{H7}		

Options

ϕ Additional charge applies

¹⁾ Typical values; can vary ± 3 mm due to casting and production tolerances

Other available options

- Nickel plated – cast parts are electroless nickel plated, steel components black oxide finished, aluminium anodized, precision steel surfaces are untreated
- Custom Paint – press and column can be painted to customer's color specification
- Bores for adapting tooling – customer specific sizes can be supplied

Bottom view of the press head

Fastening drill pattern flange/ram

Press Type 329

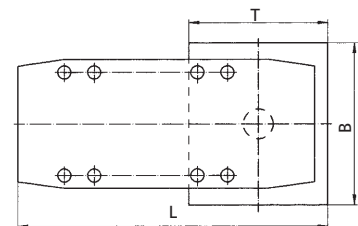
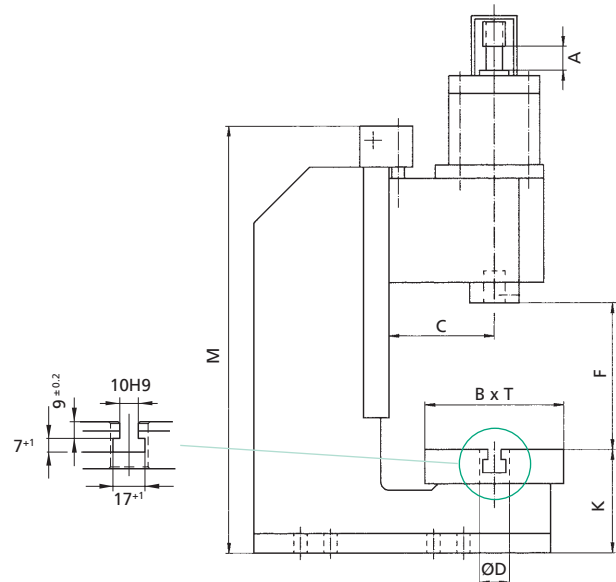
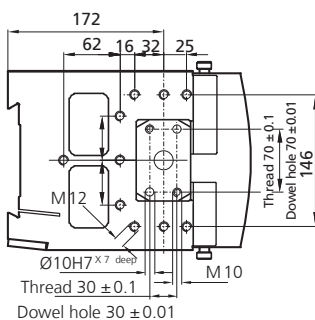

Detailed dimensional drawings can be downloaded:
www.schmidttechnology.com



SCHMIDT® PneumaticPress with PressControl 700 and two-hand release on height-adjustable PU40 and transparent guarding as EC type-examination approved single workstation.

SCHMIDT® HydroPneumaticPress

Maximum force range from 15 kN to 220 kN

The **SCHMIDT® HydroPneumaticPress** range builds on a modular concept and can generate up to 220 kN. They are ideally suited for joining, assembly and forming applications. With the addition of the **SCHMIDT® PressControl 75** or **700** and the optional process monitoring, these presses become EC type-approved, CE-conformed workstations. Therefore these press systems can be used in either single cycle or automatic mode.

The application determines selection of the press system. Consideration is given to the flexible design of the assembly location taking into account the ergonomic and safety aspects. These characteristics are achieved by means of a finely adjusted, modular type product range. The efficiency and increased process reliability of these press systems have been proven many times, in single applications, semi-automated assembly systems and have been integrated into automated production lines.



SCHMIDT® HydroPneumaticPress

System design



- 1 Cylinder unit**
Hydro pneumatic
- 2 Flow control rapid approach stroke**
For speed control of the downstroke
- 3 Press head unit**
Modular design allows for quick and accurate height adjustment when installed on our column or the system can be easily integrated, in any orientation, to an automated press solution.
- 4 Pneumatic control package**
Two-channel pneumatic package (as shown) is based on a modular valve block
- 5 Force output preselector**
The press force output can easily be controlled via a separate pressure regulator and pressure gauge. The pressure for the power stroke can be reduced to 1 bar
- 6 Square ram**
Square ram with precision machine bore and fully adjustable Teflon line gibs for precise ram guidance.
- 7 Frame**
With precision machined press head guide rails (for No. 68 and 368 designed as dovetail guide)
- 8 Fixture mounting plate**
With precision T-slot and precision bore for tool location



Stroke feedback

Ram with key-ways for switch target pieces for an inductive position feedback. Optional: Stroke-dependent activation of the power stroke by means of the proximity switch.

SCHMIDT® HydroPneumaticPress

Principle of operation

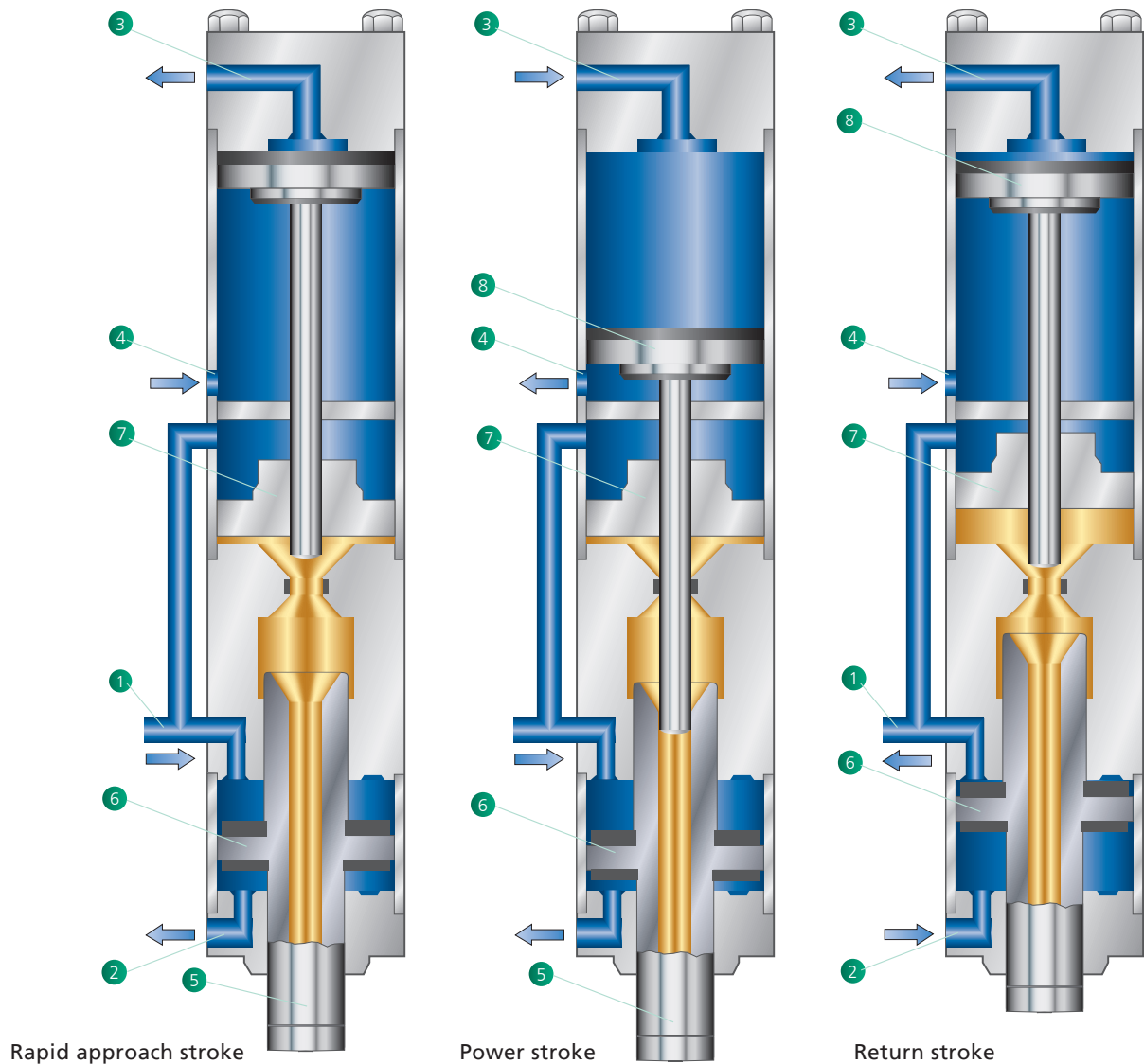

Rapid approach stroke

In rapid approach stroke, the air connections 1 and 4 are pressurized with compressed air. The air connections 2 and 3 are depressurized. The approach stroke piston 6 and the reservoir piston 7 are moving with low force until the ram 5 encounters resistance.

Power Stroke

If the ram 5 encounters resistance, a valve switches the compressed air from 4 to connection 3, and the power stroke piston 8 moves downwards. A rod enters the high pressure cylinder, separating the hydraulic oil between reservoir piston 7 and approach stroke piston 6. The ram 5 moves out with boosted force.

Return Stroke

For the return stroke, the connections 1 and 3 are depressurized, and the connections 2 and 4 are pressurized. Approach stroke 6 and power stroke piston 8 move back simultaneously. After the hydraulic connection between approach 6 and reservoir piston 7 oil flows back into the reservoir, moving the reservoir piston into its home position.

Characteristics

- Optimally adapted to individual requirements due to its modular design
- High flexibility and economic efficiency due to short changeover times
- Easy and accurate positioning of tools due to the precise alignment between ram bore and the ground fixture mounting plate.
- The force output preselector allows reducing the pressure for the power stroke to 1 bar. This reduces the nominal press force to 1/6 of the maximum force.
- The end positions of the ram can be sensed via the inductive proximity switches.
- No mechanical compression spring in the cylinder of the hydro-pneumatic system, providing a long service life
- Low maintenance resulting in high productivity
- Long service life and precision due to maintenance-free guides
- Tool protection due to smooth switchover from rapid approach stroke to power stroke
- Additional safety when using heavy tools due to the optional ram drift lock device for retention of ram in home position.
- Low noise level (< 75 dBA)

SCHMIDT® HydroPneumaticPress

C-Frame design

Characteristics

- The C-Frame design offers full accessibility when manually inserting and removing parts
- Easy adaptation to different tool and part heights because of simplistic height adjustment with angular gear
- Anti-rotational square ram with fully adjustable, Teflon lined gibs for precise travel. No die set required
- High precision due to long precise guides of the square ram



Press type 61/62



Press type 65

Adjustable switch target pieces for position detection via an inductive position sensor

Rapid approach stroke

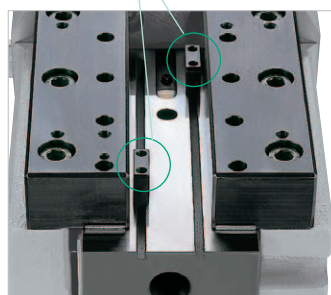
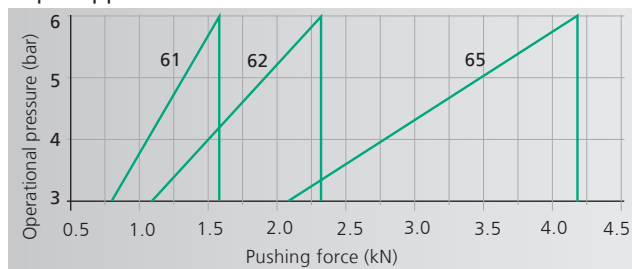

Square ram with bilaterally adjustable, play-free gibs, precision machined bore with set screw for mounting of tooling.

Power stroke

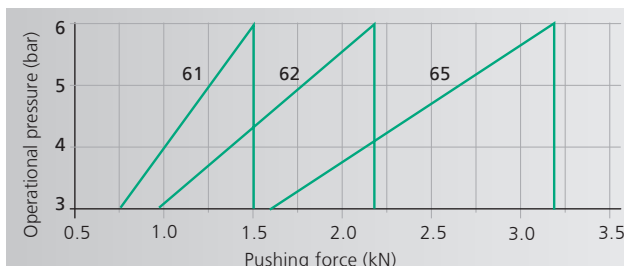
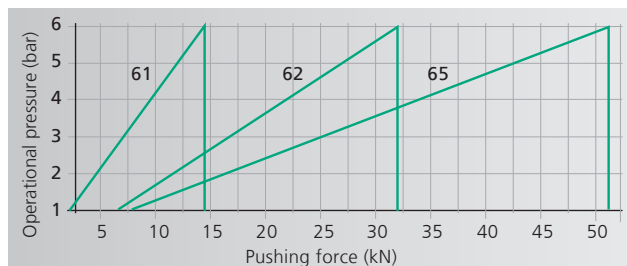

Operational pressure <3 bar: can only be operated with press force preselector!

From 15 kN to 52 kN in power stroke

Press Type			61	62	65
Total stroke – power stroke ¹⁾		mm	50 – 6, 100 – 12	50 – 6, 100 – 12	50 – 6, 100 – 12
Nominal force at 6 bar		kN	15	30	52
Throat depth	C	mm	131	131	160
Throat depth frame \circ		mm	151	151	185
Fixture mounting plate suitable for throat depth frame			\circ	\circ	\circ
Ram bore	\emptyset	mm	20H7	20H7	20H7
External ram dimensions	G x H	mm	36 x 63	36 x 63	46 x 86
Working height ²⁾	F				
Frame No. 34		mm	100 – 250	100 – 250	
Frame No. 301 \circ		mm	160 – 400	160 – 400	
Frame No. 301-500 \circ		mm	310 – 550	310 – 550	
Frame No. 35		mm			80 – 270
Frame No. 35-500 \circ		mm			150 – 500
Frame No. 35-600 \circ		mm			250 – 600
Weight (standard)	approx. kg		95	110	160

Frame Overview	Press Type	Frame Height M (mm)	Table Size B x T (mm)	Table Bore D \emptyset mm	Table Height K (mm)	Mounting Surface B x L (mm)
No. 34	61, 62	630	200 x 160	25H7	111	200 x 370
No. 301	61, 62	830	250 x 200	40H7	145	250 x 460
No. 301-500	61, 62	990	250 x 200	40H7	145	250 x 480
Special fixture mounting plate with 3 longitudinal slots \circ			300 x 220 400 x 230	40H7		
No. 35	65	700	300 x 220	40H7	141	300 x 480
No. 35-500	65	990	300 x 220	40H7	166	300 x 560
No. 35-600	65	1110	300 x 220	40H7	166	300 x 585
Special fixture mounting plate with 3 longitudinal slots \circ			355 x 225 400 x 280	40H7		

Options

\circ Additional charge applies

¹⁾ Total stroke / power stroke options on request

²⁾ Typical values; can vary ± 3 mm due to casting and production tolerances

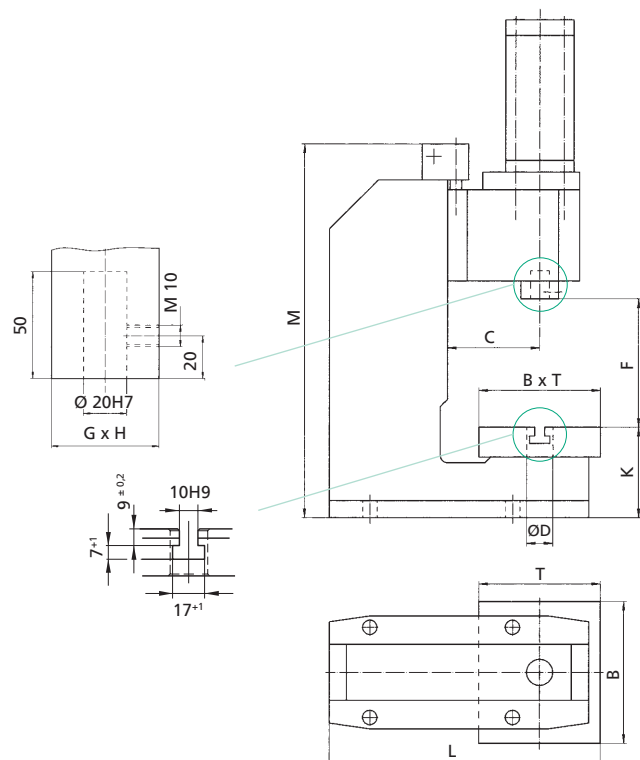

Detailed dimensional drawings can be downloaded:
www.schmidttechnology.com

SCHMIDT® HydroPneumaticPress

C-Frame design with welded press frame

Characteristics

- The welded press frame offers highest stability
- Space-saving and compact due to separate working cylinder for press No. 68



Press type 68



Press type 64



Square ram

with bilaterally adjustable, play-free gibs, precision machined bore with set screw for mounting of tooling. Some models feature additional provisions for tooling adaption.

Rapid approach stroke

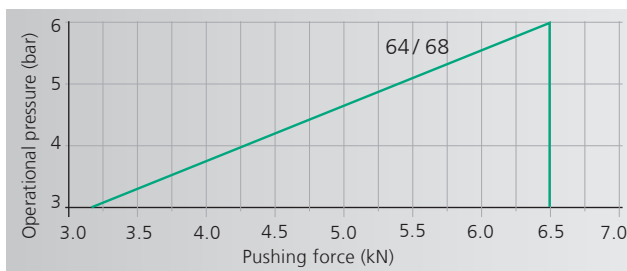

Fixture mounting plate

(for Press No. 64) with 3 T-slots and precision machined bore for tool location.

Power stroke

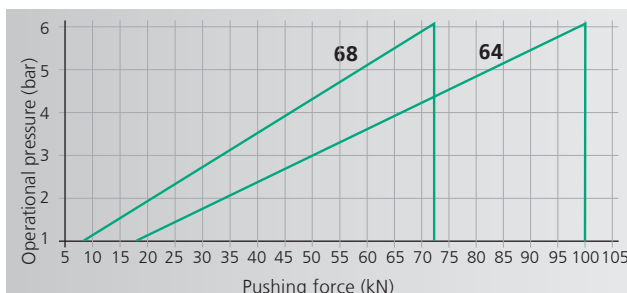

Return stroke

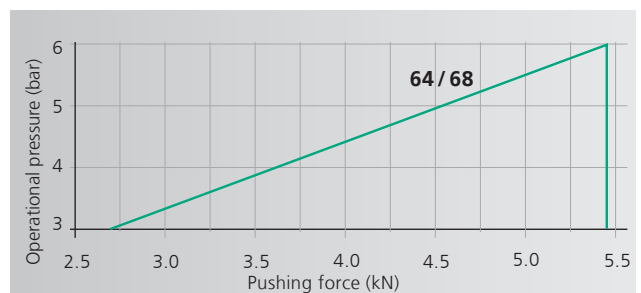

Operational pressure <3 bar: can only be operated with press force preselector!

From 72 kN to 100 kN in power stroke

Press Type			64	68
Total stroke - Power stroke ¹⁾		mm	50-6, 100-12	50-6, 100-12
Nominal force at 6 bar		kN	100	72
Throat depth	C	mm	160	160
Ram bore	E	Ø mm	25H7	20H7
External ram dimensions	G x H	mm	60 x 90	60 x 90
Working height ³⁾	F			
Frame No. 64		mm	180-350	
Frame No. 64-600 o		mm	430-600	
Frame No. 68 ²⁾		mm		130-300
Frame No. 68/5 ²⁾ o		mm		190-460
Weight (standard)		approx. kg	420	350

Frame Overview	Press Type	Frame Height M (mm)	Table Size B x T (mm)	Table Bore D Ø mm	Table Height K (mm)	Mounting Surface B x L (mm)
No. 64	64	940	400 x 290	40H7	185	400 x 625
No. 64-600 o	64	1200	400 x 290	40H7	185	400 x 685
No. 68 ²⁾	68	810	300 x 230	40H7	147	300 x 550
No. 68/5 ²⁾ o	68	990	300 x 230	40H7	147	300 x 620
Special fixture mounting plate with 3 longitudinal slots o			400 x 280 500 x 280	40H7		

Options

o Additional charge applies

¹⁾ Total stroke / power stroke options on request

²⁾ Frame 68/5 required for 30 mm power stroke

³⁾ Typical values; can vary ±3 mm due to casting and production tolerances

Bottom view of the press head

Mounting drill pattern flange/ram

Press type 64

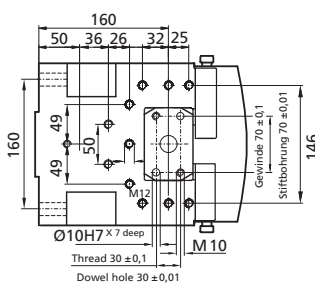

Press type 68

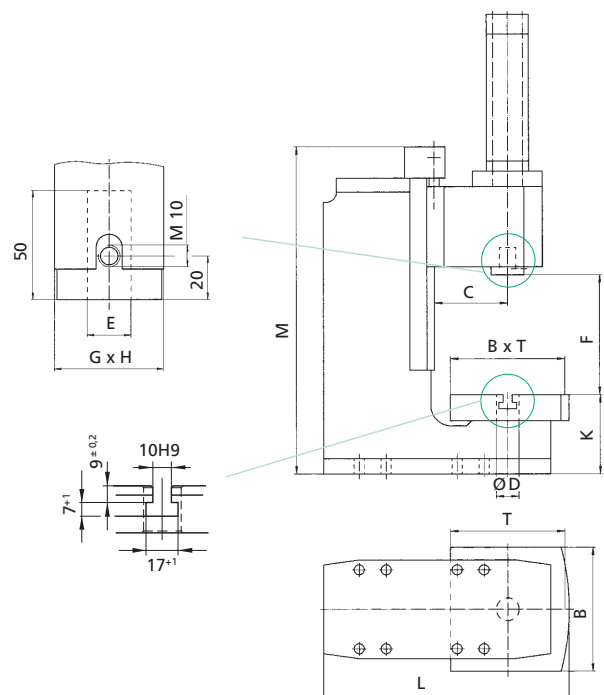
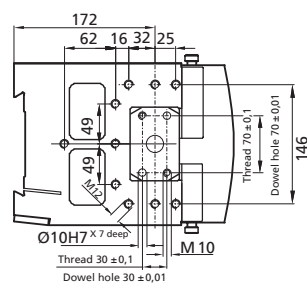

Detailed dimensional drawings can be downloaded:
www.schmidttechnology.com

SCHMIDT® HydroPneumaticPress

C-Frame design with force/stroke monitoring

SCHMIDT® HydroPneumaticPresses with force / stroke monitoring are offered as complete systems with control unit SCHMIDT® PressControl 700 and 7000. These systems are characterized by sensors and signal amplification integrated in the press head. These signals are evaluated in real time.

Characteristics

- Direct forces are measured due to the force sensor integrated in the ram. Insensitive against side forces
- Signal readings are not affected by outside interference
- A measuring data amplification integrated in the press head provides short transmission paths of unamplified signals
- Precision guide rails for precise working. Bilaterally adjustable, play-free gibs, precision machined bore for tool location. No die-set required
- Weld constructed steel frames to minimize frame flex.



Press type 361



Press type 362



Press type 365

Rapid approach stroke

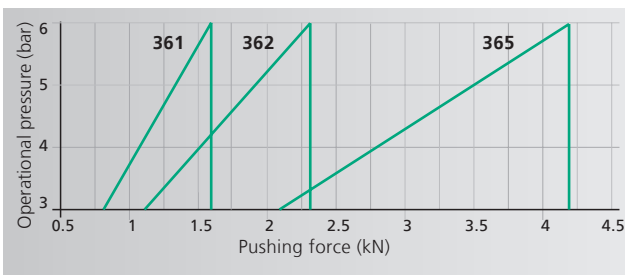

Power stroke

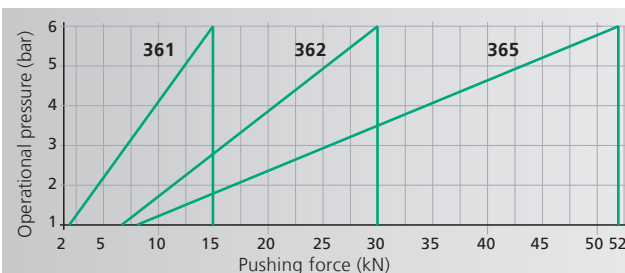

Return stroke

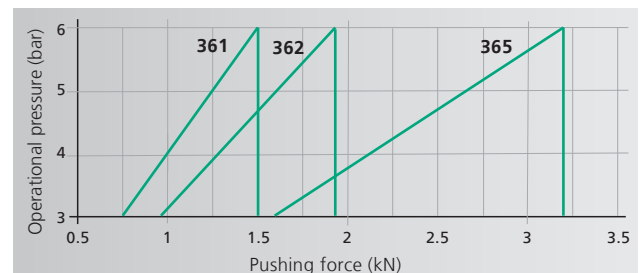

Operational pressure <3 bar: can only be operated with press force preselector!

From 15 kN to 52 kN in power stroke

Press Type		361	362	365
Total stroke - Power stroke ¹⁾	mm	50-6, 100-12	50-6, 100-12	50-6, 100-12
Nominal force at 6 bar	kN	15	30	52
Process data acquisition stroke force	µm/inc	5	5	5
	N/inc	4.5	9	15
Throat depth	C mm	131	160	160
Throat depth frame \varnothing		151		
Fixture mounting plate suitable for throat depth frame		\varnothing		
Ram bore	\varnothing mm	20H7	20H7	20H7
External ram dimensions	G x H mm	70 x 50	90 x 60	90 x 60
Working height ²⁾	F			
Frame No. 301	mm	160-355		
Frame No. 301-500 \varnothing	mm	310-500		
Frame No. 329	mm		130-300	130-300
Frame No. 329-460 \varnothing	mm		190-460	190-460
Weight (standard)	approx. kg	170	320	330

Frame Overview	Press Type	Frame Height M (mm)	Table Size B x T (mm)	Table Bore D \varnothing mm	Table Height K (mm)	Mounting Surface B x L (mm)
No. 301	361	830	250 x 200	40H7	145	250 x 460
No. 301-500 \varnothing	361	990	250 x 200	40H7	145	250 x 480
Special fixture mounting plate with 3 longitudinal slots \varnothing			300 x 220 400 x 230	40H7		
No. 329	362, 365	810	300 x 230	40H7	147	300 x 550
No. 329-460 \varnothing	362, 365	990	300 x 230	40H7	147	300 x 620
Special fixture mounting plate with 3 longitudinal slots \varnothing			400 x 280 500 x 280	40H7		

Options

\varnothing Additional charge applies

¹⁾ Total stroke / power stroke options on request

²⁾ Typical values; can vary ± 3 mm due to casting and production tolerances

Bottom view of the press head

Mounting drill pattern flange/ram

Press Type 361

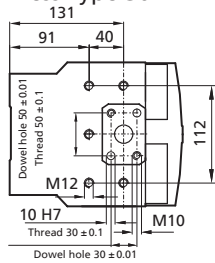

Press Type 362/365

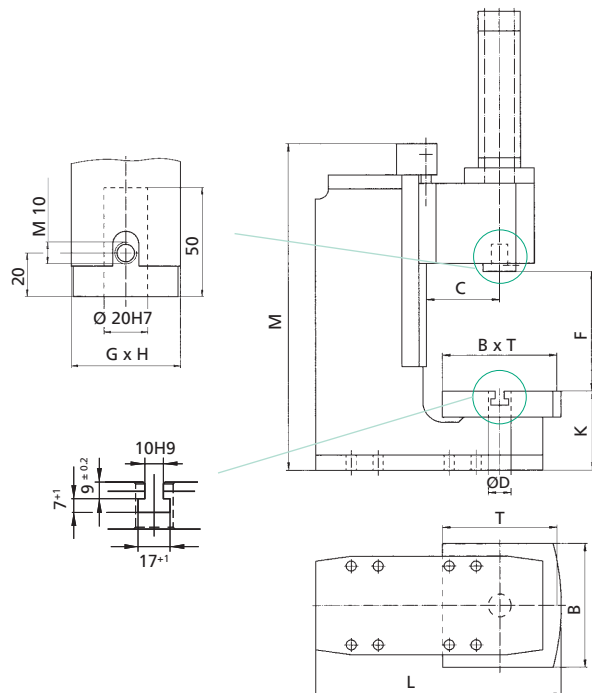
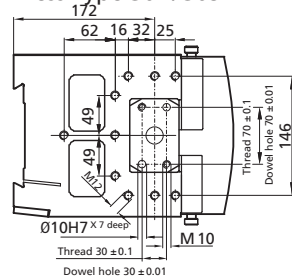

Detailed dimensional drawings can be downloaded:
www.schmidttechnology.com

SCHMIDT® HydroPneumaticPress

In C-Frame design with force/stroke Monitoring

SCHMIDT® HydroPneumaticPress with force/stroke monitoring are offered as complete systems with control unit SCHMIDT® PressControl 700 and 7000. These systems are characterized by sensors and signal amplification integrated in the press head. These signals are evaluated in real time.

Characteristics

- Direct forces are measured due to the force sensor integrated in the ram. Insensitive against side forces
- Signal readings are not affected by outside interference
- A measuring data amplification integrated in the press head provides short transmission paths of unamplified signals
- Precision bilaterally adjustable, play-free gibs, precision ground bore for tool location. No die-set required
- Weld constructed steel frames to minimize frame flex.



Press type 364



Press type 368

Rapid approach stroke

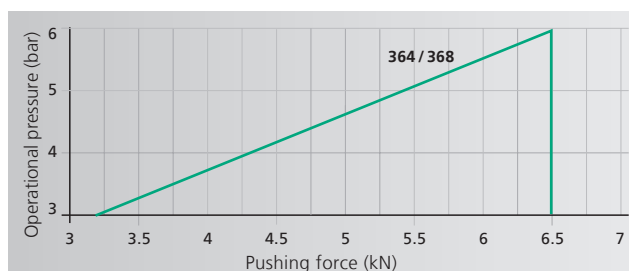

Power stroke

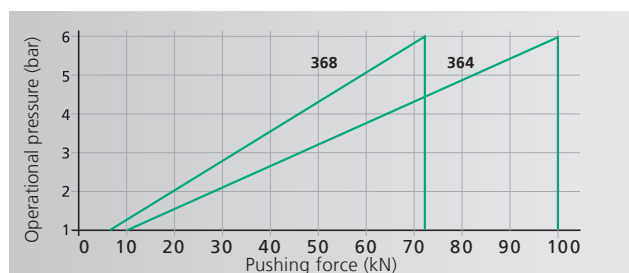

Return stroke

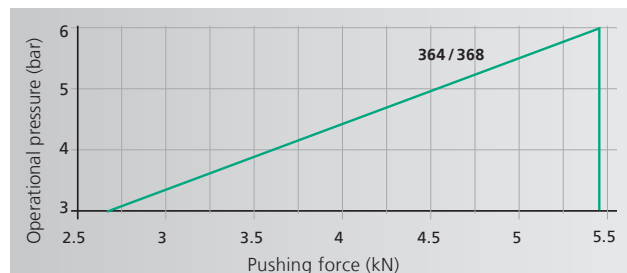

From 72 kN to 100 kN in power stroke

Press Type			364	368
Total stroke - Power stroke ¹⁾		mm	50-6, 100-12	50-6, 100-12
Nominal force at 6 bar		kN	100	72
Process data acquisition				
Stroke		µm/inc	5	5
Force		N/inc	32	20
Throat depth	C	mm	160	160
Ram bore	E	Ø mm	25H7	20H7
External ram dimensions	G x H	Ø mm	90 x 60	90 x 60
Working height ³⁾	F			
Frame No. 64		mm	180-350	
Frame No. 64-600 o		mm	430-600	
Frame No. 68 ²⁾		mm		130-300
Frame No. 68/5 ²⁾ o		mm		190-460
Weight (standard)		approx. kg	420	350

Frame Overview	Press Type	Frame Height M (mm)	Table Size B x T (mm)	Table Bore D Ø mm	Table Height K (mm)	Mounting Surface B x L (mm)
No. 64	364	940	400 x 290	40H7	185	400 x 625
No. 64-600 o	364	1200	400 x 290	40H7	185	400 x 685
No. 68 ²⁾	368	810	300 x 230	40H7	147	300 x 550
No. 68/5 ²⁾ o	368	990	300 x 230	40H7	147	300 x 620
Special fixture mounting plate with 3 longitudinal slots o			400 x 280 500 x 280	40H7		

Options

o Additional charge applies

¹⁾ Total stroke / power stroke options on request

²⁾ Frame 68/5 required for 30 mm power stroke

³⁾ Typical values; can vary ±3 mm due to casting and production tolerances

Bottom View of the Press Head Mounting drill pattern flange/ram

Press Type 364

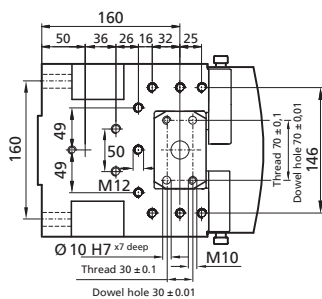

Press Type 368

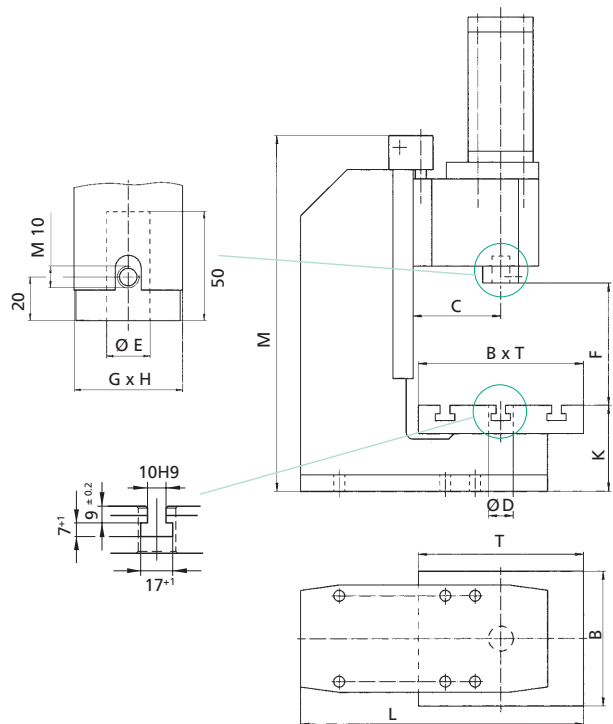
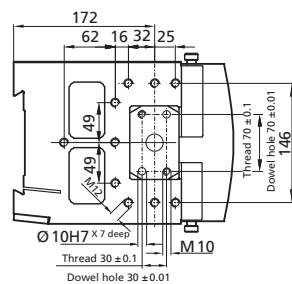

Detailed dimensional drawings can be downloaded:
www.schmidttechnology.com

SCHMIDT® HydroPneumaticPress

H-Frame design with and without force/stroke monitoring

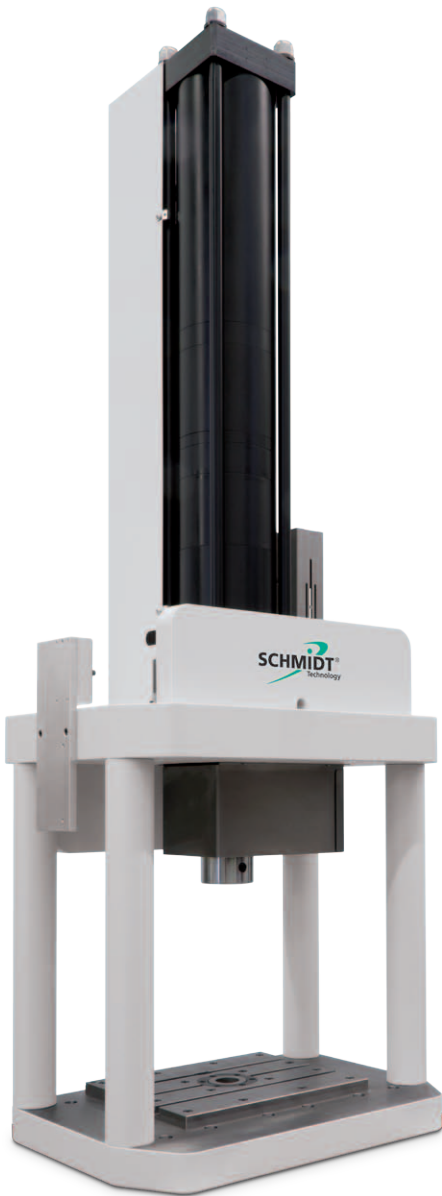

Press type 74/76
374/376 (with force/stroke monitoring)

Characteristics

- Stable frame with low bending for the absorption of high forces
- Flexible tool location in the fixture mounting plate due to replaceable centering bushing with precision bore
- The large working area offers sufficient space for large tools
- The force is determined via a pressure transducer with force/stroke monitored presses

Round ram locked against rotation with TDC switch (74/76) or position measuring system (374/376) on the anti-rotational guide rod.

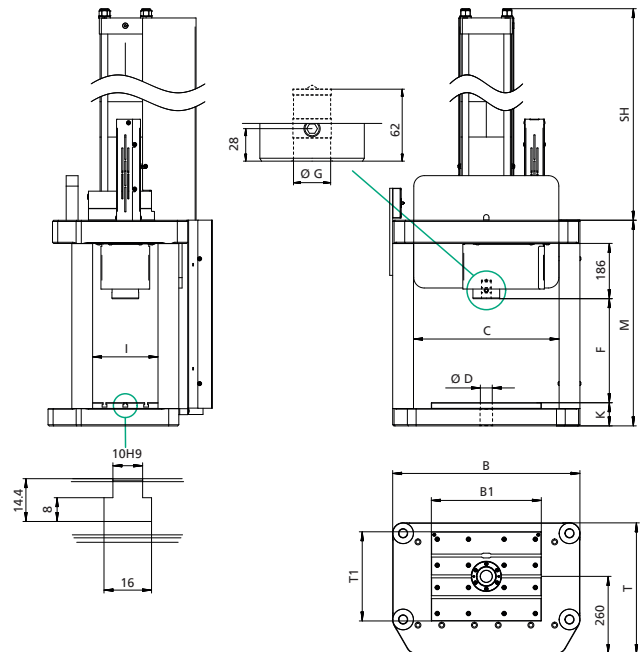

Rapid approach stroke

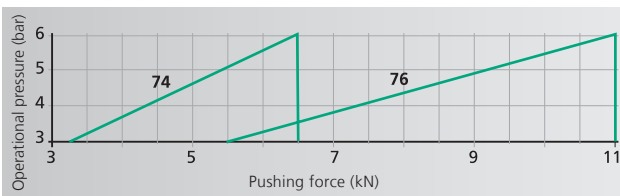

Power stroke

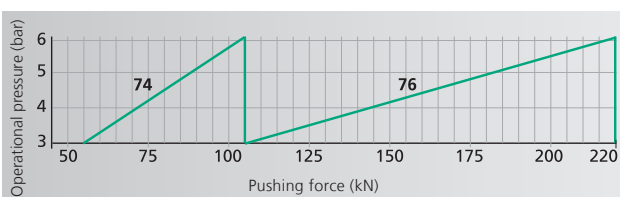

Return stroke

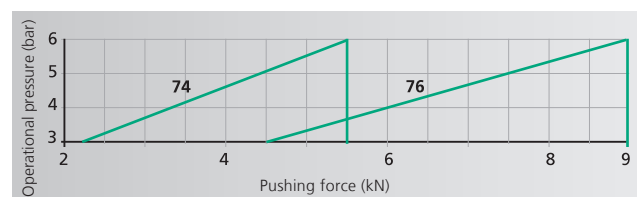

From 100 kN to 220 kN in power stroke

Press Type			74		76	
Total stroke – power stroke ¹⁾		mm	100–12	150–22	100 – 12	150 – 20
Nominal force at 6 bar		kN	100	100	220	220
Ram bore	G	Ø mm	25 ^{H7}	25 ^{H7}	32 ^{H7}	32 ^{H7}
External ram dimensions		Ø mm	90	90	90	90
Working height ²⁾	F		350	350	350	350
Press head height	SH		920	1185	1160	1400
Frame height	K	mm	78	78	78	78
H-frame height	M	mm	692	692	692	692
Floor space required	B x T	mm	630 x 440	630 x 440	630 x 440	630 x 440
Table size	B x T	mm	370 x 300	370 x 300	370 x 300	370 x 300
Table bore	D	Ø mm	40 ^{H7}	40 ^{H7}	40 ^{H7}	40 ^{H7}
Clearance	C	mm	490	490	490	490
Clearance side	I	mm	220	220	220	220
Weight (standard)		approx. kg	550	605	610	665

Press Type			374		376	
Total stroke – power stroke ¹⁾		mm	100–12	150 – 22	100–12	150 – 20
Nennkraft bei 6 bar		kN	100	100	220	
Process data acquisition – stroke		µm/inc	5	5	5	5
– force		N/inc	32	32	62,5	62,5
Ram bore	G	Ø mm	25 ^{H7}	25 ^{H7}	32 ^{H7}	32 ^{H7}
External ram dimensions		Ø mm	90	90	90	90
Working height ²⁾	F		350	350	350	350
Press head height	SH		920	1185	1160	1400
Frame height	K	mm	78	78	78	78
H-frame height	M	mm	692	692	692	692
Floor space required	B x T	mm	630 x 440	630 x 440	630 x 440	630 x 440
Table size	B1 x T1	mm	370 x 300	370 x 300	370 x 300	370 x 300
Table bore	D	Ø mm	40 ^{H7}	40 ^{H7}	40 ^{H7}	40 ^{H7}
Clearance	C	mm	490	490	490	490
Clearance side	I	mm	220	220	220	220
Weight (standard)		approx. kg	550	605	610	665

Options

- ¹⁾ Total stroke / power stroke options on request
- ²⁾ Typical values; can vary ±3 mm due to casting and production tolerances

Accessories



High-pressure switch

After switching from rapid approach stroke to power stroke, the oil pressure rises in the hydraulic chamber of the cylinder. The high-pressure switch can be adjusted to reach a determined press force through the output generated by the oil pressure in the press.



Adjustment bushing for SCHMIDT® HydroPneumatic-Press No. 74 and 76

For a simplistic adjustment of the working height with a setting range of 100 mm. This greatly reduces the need for spacers to accommodate different working heights during setup changes.



Oil pump

For an air-free refilling of the SCHMIDT® HydroPneumatic-Press with hydraulic oil, including 1 liter Hydraulic oil.

SCHMIDT® Cylinder Units

For flexible use

SCHMIDT® Double-acting cylinder units are useful components for the construction of special machines. They can be mounted independently and are equipped with a magnet kit for detecting the corresponding end position using a cylinder switch. Direct

acting air provided as flange or side-mount models and toggle or hydropneumatic type as side mount models, achieving forces up to 100 kN.



Press head (side-mount) model



Flange model



Technical Data	SCHMIDT® Cylinder Units	
Typ No.	Press head model	Flange model
20 - 29	•	•
32 - 36	•	
61 - 68	•	• (not for No. 61, 62, 65)
323 - 368	•	•

For the performance data, please refer to the chapters **SCHMIDT® PneumaticPress** and **SCHMIDT® HydroPneumaticPress**, optional with force/stroke monitoring.

Order indications

Key for design options

<p>Cylinder unit / stroke / design</p> <p>Order example head 65 - 50 - 6</p> <p>Press no. <input type="text"/></p> <p>Total stroke <input type="text"/></p> <p>Power stroke <input type="text"/></p> <p>= SCHMIDT® Cylinder Unit No. 65 with total stroke 50 mm and power stroke 6 mm as press head model</p>	<p>Cylinder unit / stroke / design</p> <p>Order example 20 - 50 - FL</p> <p>Press no. <input type="text"/></p> <p>Stroke <input type="text"/></p> <p>Model <input type="text"/></p> <p>= SCHMIDT® Cylinder Unit no. 20 with stroke 50 mm as flange model</p>
--	---

SCHMIDT® ElectricPress

A new approach to assembly technology

The use of electric drives instead of pneumatic or hydropneumatic driven cylinders is a modern advancement in assembly technology. **SCHMIDT Technology** combined its proven rack & pinion and ServoPress experience to create a new electric drive technology, providing high efficiency, full programmability and precision in a flexible pressing system.

The success of your products depends to the highest degree on process-reliable and, above all, economical assembly:

- process-safe due to reliable quality statements
- economical due to a significant reduction in operating costs thanks to electric motor drive technology.

The synergy of both criteria is fulfilled by the press system **SCHMIDT® ElectricPress** with up to 20 kN maximum force and the controls **SCHMIDT® PressControl 75** for **SCHMIDT® ElectricPress 43** and **45** or **SCHMIDT® PressControl 700x** for the force-displacement monitored systems. These well-known and proven components for robust use in automation technology guarantee exactly this success.

The key advantage of the **SCHMIDT® ElectricPress**:

- Simple parameterisation minimises commissioning time
- Quick changeover procedures due to retrievable operating profiles
- Increased flexibility
- Cost reduction of tools and their wear due to free, precise positioning.
- The low noise level provides a stress-free working environment.
- The design-related non-existent stick-slip effect optimises the assembly process compared to pneumatic drives, especially at low speeds.

The expected high quality demands are met not least on the test bench. To determine the typical service life of 2×10^7 press cycles, the test was based on minimum requirements. The mechanical, electrical and motor components as well as the thermal behaviour of the entire system passed this stress test with flying colours.

- Real-time process monitoring
- High energy efficiency
- Simple integration
- Reproducible travel profiles
- Purely electric drive
- Height adjustable

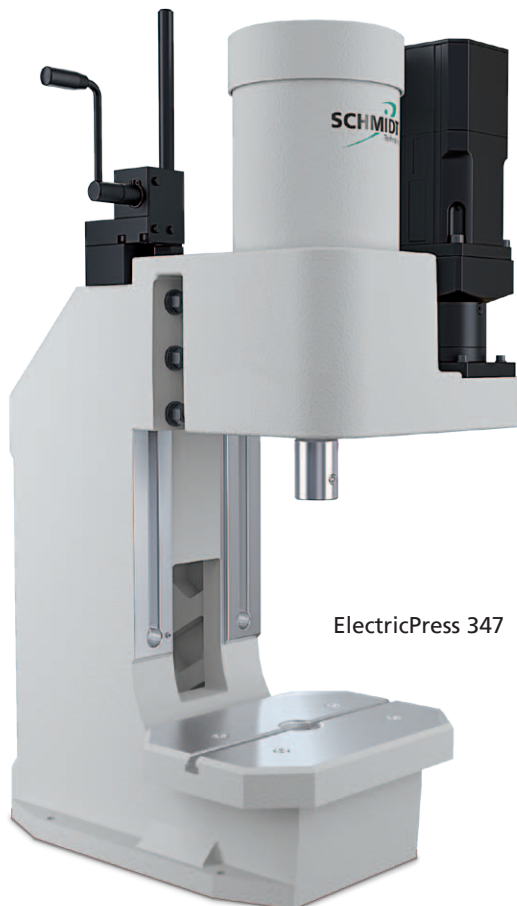

SCHMIDT® ElectricPress 43/45 with PressControl 75



SCHMIDT® ElectricPress manual workstation with SafetyModule on PU 20

SCHMIDT® PressControl 75 for quick set-up or rapid change-over and easy programming of press parameters; stores up to 24 datasets for use in manual workcells with SCHMIDT Technology's proven and certified safety technology. This combination can be used both in manual workstations as well as in automation solution.



SCHMIDT® ElectricPress 43 automation

Characteristics:

- Reproducible values for position, velocity, acceleration and deceleration
- Combination of up to 14 individual ram motion profiles into one complete profile by using a standard PLC
- Press to exact position (closed loop control stroke)
- Press to force (determined by motor current) to
 - press to final force
 - press to position but interrupt if force is exceeded
 - touch force to determine position of workpiece



SCHMIDT® ElectricPress 343/345 with PressControl 700/7000

Paired with a **SCHMIDT®** PressControl 700 or PressControl 7000 the ElectricPress becomes a force/stroke monitored system. Its closed-loop force and position control ensures highest accuracy and facilitates the programming of complex ram motion profiles for a wide variety of pressing applications.

In addition to the position controller, **SCHMIDT®** ElectricPress also works with a real force controller (force as a controlled variable).

- Rapid approach of target force or position
- No over-shoot of programmed force or position
- Positioning accuracy in a range of 1/100 mm under constant loads
- Perfectly adapts to each application
- Pre-programmed with optimal acceleration/deceleration values
- Graphic display of force/time and stroke/time facilitates cycle time optimization



Single workstations

In conjunction with type-examined safety techniques **two-hand** release, light curtain and **SCHMIDT®** SmartGate

Automation

SCHMIDT® ElectricPress 343, 345 and 347 with **SCHMIDT®** PressControl 7000 control for automation solution

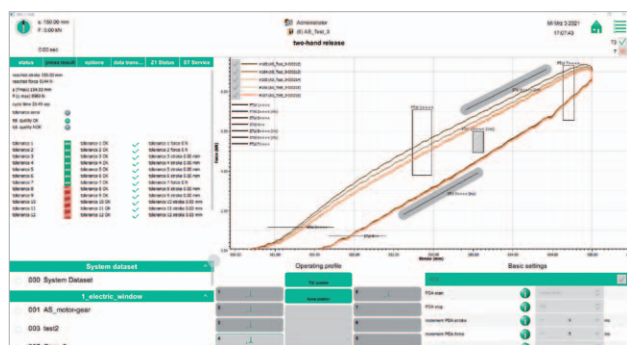

Process visualization



SCHMIDT® ElectricPress 347 automation

SCHMIDT® ElectricPress

Technical Data 43/343/45/345

Press Type			43	343	45	345
Force F max. ¹⁾		kN	4	4	10	10
Force F at 100 % duty cycle ²⁾		kN	2,5	2,5	6	6
Ram stroke	A	mm	100	100	150	150
Ram speed max.		mm/s	200	200	200	200
Drive resolution		µm	< 1	< 1	< 1	< 1
Resolution PDA						
- Stroke		µm/inc		1,69		2,4
- Force		N/inc		1,25		3,0
Throat depth	C	mm	129	129	129	129
Decibel level		dBA	60	60	60	60
Power supply						
- motor power			208 – 240 V AC ±10 %	208 – 240 V AC ±10 %	208 – 240 V AC ±10 %	208 – 240 V AC ±10 %
- logic unit			24 V DC / 2 A	24 V DC / 2 A	24 V DC / 2 A	24 V DC / 2 A
Working height frame 7-420 ³⁾			62 – 420	62 – 420	50 – 360	50 – 360
Working height frame 7-600 ³⁾	F	mm	100 – 610	100 – 610		
S-H x S-B x S-T		mm	402 x 207 x 385	402 x 240 x 385	530 x 245 x 410	530 x 275 x 410
Weight		kg	35	35	59	59
PRC Gateway, number of I/O's				16 inputs / 16 outputs		16 inputs / 16 outputs

Frame Overview	Press Type	Frame Height M (mm)	Table Size B x T (mm)	Table Bore D Ø (mm)	Table Height K (mm)	Mounting surface (mm)
No. 7-420	43, 343, 45, 345	740	180 x 150	20 ^{H7}	90	220 x 362
No. 7-600	43, 343	960	180 x 280	20 ^{H7}	110	220 x 465

- 1) Temporary peak load
- 2) Nominal power in continuous operation
- 3) Typical values; can vary ±3 mm due to casting and production tolerances

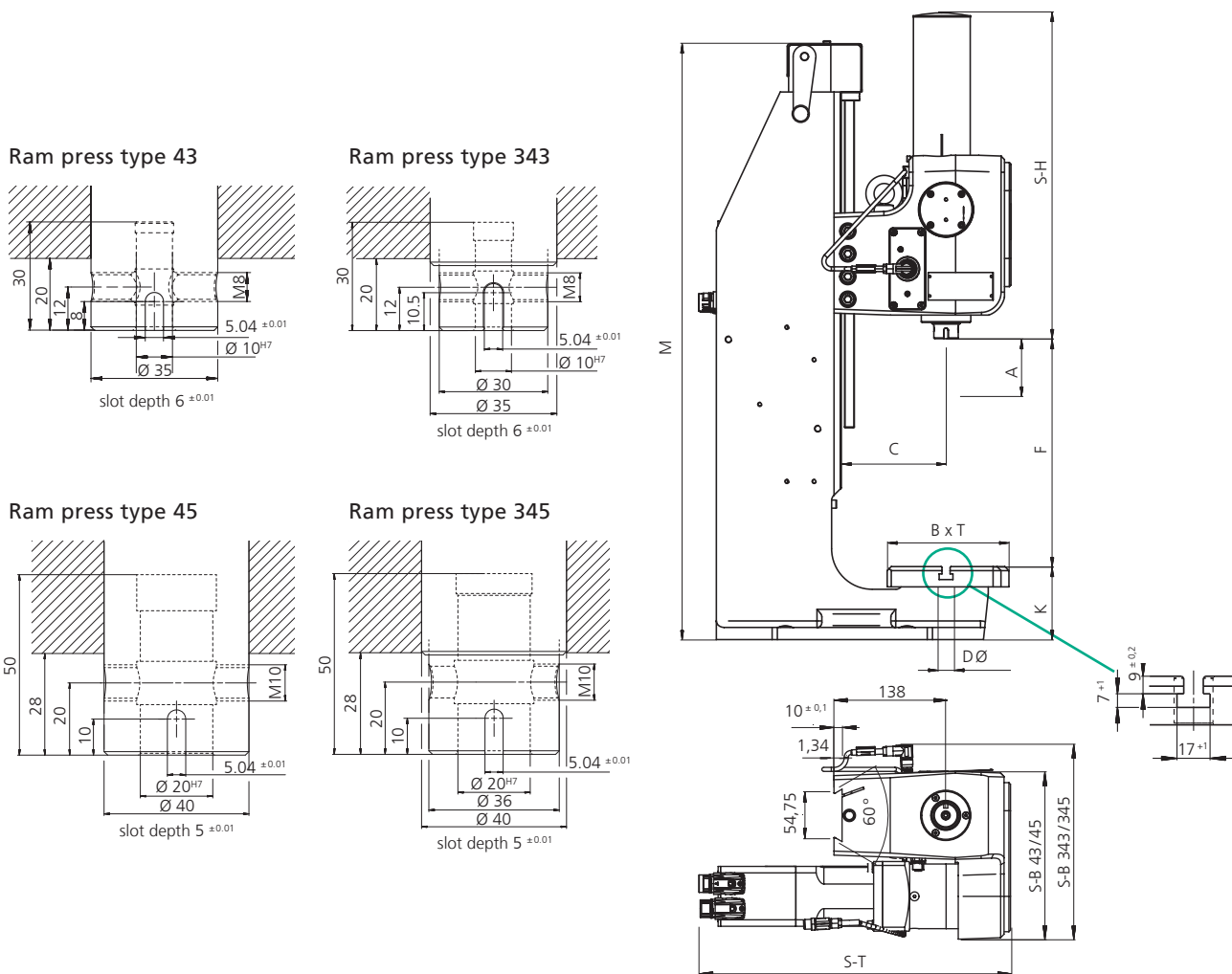

SCHMIDT® ElectricPress

Technical Data 347

Press type			347
Force F max. ¹⁾		kN	20
Force F at 100 % duty cycle ²⁾		kN	13
Ram stroke	A	mm	150
Ram stroke max.		mm/s	100
Drive resolution	E	µm	< 1
Resolution PDA			
– stroke		µm/inc	2,30
– force		N/inc ³⁾	6,25
Throat depth	C	mm	160
Decibel level		dB A	66
Power supply			208 – 240 V AC ±10 %
– motor power			1.3 kW
– logic unit			24 V DC / 2 A
Working height			
frame 35 ³⁾	F	mm	18 – 225
frame 35-500 ³⁾			80 – 495
frame 35-600 ³⁾			196 – 612
S-H x S-B x S-T		mm	464 x 298 x 261
Weight		kg	66
PRC Gateway, number of I/O's			16 inputs / 16 outputs

Frame overview	Press type	Frame Height M (mm)	Table Size W x D (mm)	Table Bore D (Ø mm)	Table Height K (mm)	Mounting Surface W x L (mm)	Frame Weight (kg)
No. 35	347	688 / (846) ⁶⁾	300 x 220	40H7	141	300 x 475	99
No. 35-500	347	983 / (1371) ⁶⁾	300 x 220	40H7	166	300 x 560	213
No. 35-600	347	1100 / (1488) ⁶⁾	300 x 220	40H7	166	300 x 590	242

- ¹⁾ Temporary peak load
- ²⁾ Nominal power in continuous operation
- ³⁾ Typical values; can vary ± 3 mm due to casting and production tolerances
- ⁶⁾ incl. threaded rod Höhenverstellung

Ram press type 347

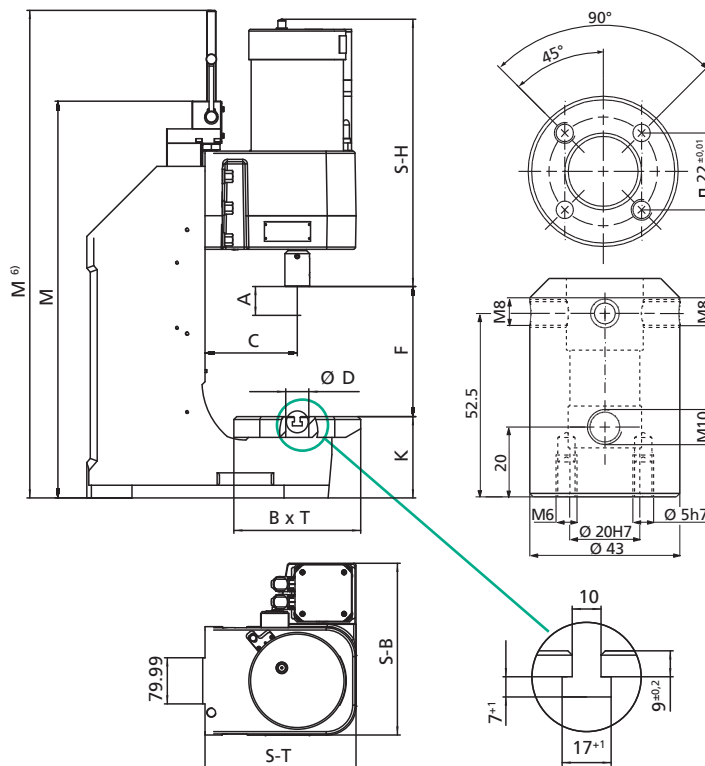

SCHMIDT® ServoPress

Forces ranging from 0.03 kN to 250 kN

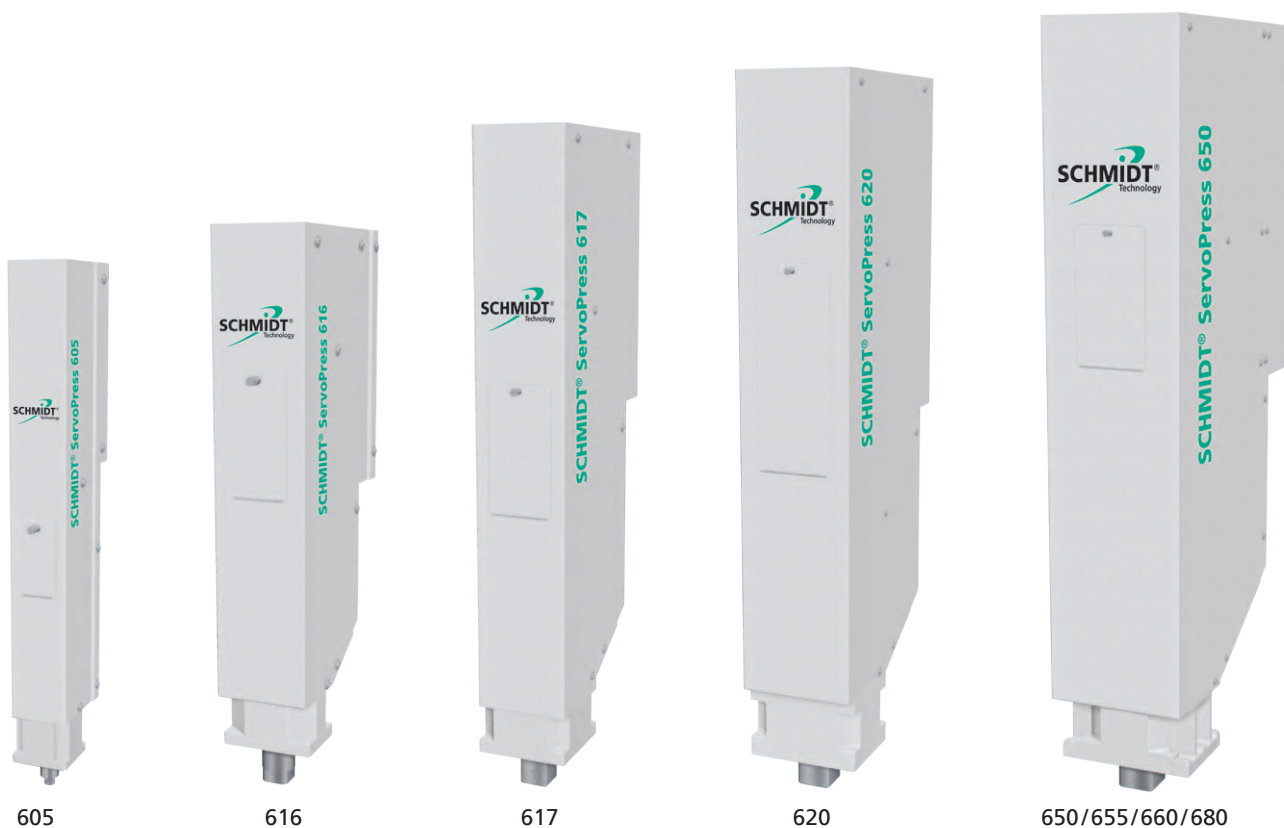

Cost-effective assembly is crucial for product success. The aim is to produce accurate, complex assemblies using inexpensive, widely accepted individual components. For **SCHMIDT® ServoPress** systems, this has not been a challenge for decades but an everyday reality, even in tough industrial environments.

The modules serve as parts in assembly systems and, along with our safety technology, are used in single workstations.



SCHMIDT® ServoPress 602

For assembly tasks in the field of fine and micromechanics, the bar for precision has been elevated even further. The high-precision **SCHMIDT® ServoPress 602** enhances the product line with unmatched accuracy and repeatability in force and position.



Full load resistance



Integrated energy management



Absolute, direct position measuring system



Machine protection



Service-friendly design



Ergonomic features

SCHMIDT® ServoPress Modules

For a broad range of applications

The unrivaled solid construction of the **SCHMIDT® ServoPress** is the foundation for precision assembly results, even in the most rugged industrial environments. Before released for serial production, each newly designed press module undergoes test bench validation under the harshest of conditions. It is this testing that provides valuable insights for improvement of the design. A test run consist of 20 million cycles with maximum stroke, at full speed and pressing to full force while subjecting the ram to side loads.

Direct ram stroke measuring system

Precision sensor and scale integrated into the press module for direct ram stroke measurement. Tied directly to the PLC/CNC of the system for positioning based on ram location.

- Micron level positioning repeatability thanks to high resolution
- Compression compensation under full load
- Correction of ball bearing pitch inaccuracies
- Temperature related material expansions/contractions do not impact measuring results
- High resolution position feedback for process monitoring

Integrated load cell

Load cell tied into the control of the system to provide:

- True closed loop force control of the ram movement.
- No overshoot of the programmed force
- A constant force regardless of part / environment / system changes.
- True force feedback for process monitoring

Nominal force of module available

- 100 % of the time
- At any ram position
- For any duration
- Maximum force available in S3 Mode

System Protection

- Automatic spindle lubrication system
- Overload protection clutch (except ServoPress 605)
- Active cooling and thermal monitoring of electronic and mechanical components
- Current limiter

Maintenance friendly

- Automatic spindle lubrication system
- Integrated used grease depot
- No filters
- Plug-and-play module recognition

Integrated and EC type-approved operator safety with light-curtain, SmartGate and SmartGuard work cells.

ServoPress 650, 655, 660 and 680 are equipped with brake energy recuperation technology.

What does this mean for you?

- Highest degree of efficiency
- Maximum operational availability
- Highest reliability



Modules

With force from 0.5 kN to 250 kN

Press type		605	616	617	620	650	655	660	680
Force F max. S3 25 %, 20 s	kN	1	5	14	35	75	110	160	250
Force F 100 % continuous run	kN	0.5	3	7.5	20	50	80	110	200
Ram stroke	mm	150	200	300	400	500	500	350	350
Ram speed	mm/s	0 – 300	0 – 200	0 – 200	0 – 200	0 -200	0 -100	0 – 100	0 – 50
Resolution position control	µm	0.1	0.1	0.1	0.1	0.1	0.1	0.1	0.1
Resolution PDA stroke	µm/inc	2.2	3.2	4.6	6.1	7.6	7.6	5.4	5.4
Resolution PDA force	N/inc	0.3	1.5	3.75	10	24	32	48	75
Power supply (V AC / 50 – 60 Hz)	V AC ±10 %	208 – 240	208 – 240	400 – 480 /3~	400 – 480 /3~	400 – 480 /3~	400 – 480 /3~	400 – 480 /3~	400 – 480 /3~
Module dimensions									
A	mm	574	535	800	957	1130	1130	1249	1249
G	mm	62	63.5	92	120	120	120	-	-
B	mm	155	252	318	384	555	555	552	552
D1	mm	89	124	144	190	244	244	249	249
U	mm	40	50	60	60	60	60	67	114
Weight module	kg	11.6	25	64	113	225	225	283	283
Dimensions with C/H-frame SH2/SB2/SL6	mm	1015 / 160 / 365	1062 / 220 / 405	1467 / 250 / 460	1810 / 300 / 563	2112 / 370 / 636	2132 / 370 / 725	2136 / 390 / 761	2042 / 625 / 614
Throat depth C	mm	130	130	150	160	160	160	160	160
Working height with C/H- frame F	mm	246	300	387	518	612	602	600	500
Table bore D2	Ø	20 ^{H7}	20 ^{H7}	40 ^{H7}	40 ^{H7}	40 ^{H7}	40 ^{H7}	40 ^{H7}	40 ^{H7}
Weight with frame	kg	45	101	166	334	553	757	805	729
Ram dimensions									
Ram P	mm	Ø 25	Ø 40	42 x 42	55 x 55	65 x 65	65 x 65	Ø 90	Ø 90
Ram bore Q	mm	6 ^{H7}	10 ^{H7}	20 ^{H7}	20 ^{H7}	20 ^{H7}	20 ^{H7}	20 ^{H7}	20 ^{H7}
Ram bore depth R	mm	18	30	50	50	50	50	50	50
Tool weight max.	kg	≤5	≤15	≤25	≤50	≤100	≤100	≤100	≤100

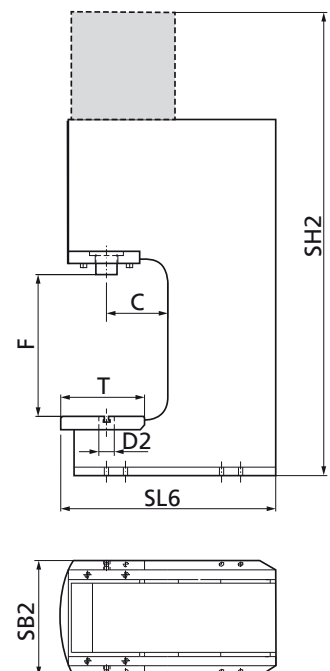
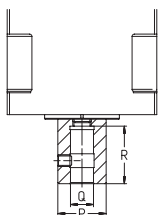
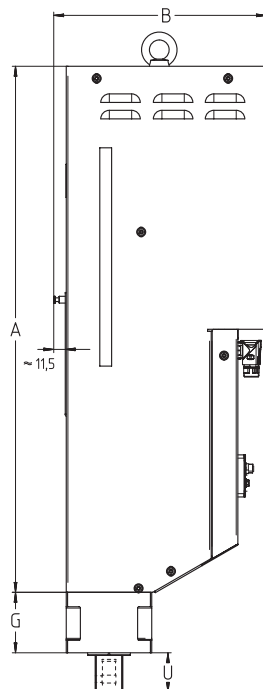
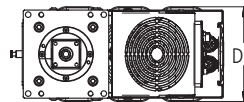

SCHMIDT® ServoPress 602

Precision in perfection

The ServoPress systems are renowned for their exceptional repeatability in the lower micrometer range. This is further enhanced by their precise force control, which delivers an accuracy of ± 1 N and a repeatability of 0.4 N.

The high-precision press incorporates either a two-hand safety concept, a light curtain, or the **SCHMIDT® SmartGuard** solution. These design features collectively enhance the press's unprecedented level of precision.

Precision Mechanics

The press ram is guided throughout the entire stroke using profile rails:

- Maximum stiffness, even at full stroke (no bending)

Force sensor integrated into the base:

- Mechanical overload protection
- Mechanical decoupling from the drive train

The press column, made of ground tool steel, is an integral part of the pressing system:

- High stiffness and dimensional accuracy

XY fine adjustment on the press table:

- Easy and precise alignment

Accuracy of Measurement Technology

Patented Absolute Position Measurement for the ram and press head:

- No need for a reference stroke to the datum position

The load cell is impervious to the effects of:

- Lateral forces
- The weight of the upper tool
- Thermal influences from the motor and mechanical friction

Standard Features

- Two air connections in the front cover plate, prepared for compressed air and/or vacuum in the work area
- Dimmable process area lighting integrated into the ram
- Status indicator (e.g. good/bad pressing result, machine status)
- Tool-free height adjustment of the press head, working height range from 86.5 – 136.5 mm
- Adapter for lubricating the ball screw, enabling lubrication in any position without removing the cover plates

The latest model in the **SCHMIDT® ServoPress** family is meticulously crafted to excel in precision pressing tasks across various industries, including precision mechanics, spring testing, medical device technology, the watch and jewelry industry, and small motor and electronics manufacturing.



SCHMIDT® ServoPress 602

Technical Data		ServoPress 602
Force F_{max}	N	300
Nominal force F 100 % ED	N	200
Ram stroke	mm	75
Working height F	mm	85.2 – 135.2
Speed	mm/s	0 – 150
Throat depth C	mm	70
Dimensions W x H x D	mm	158 x 648 x 337
Weight	kg	38 kg
Force accuracy	N	± 1
Repeatability of position	μm	± 1
Repeatability of force	N	0.4
Resolution of position	μm	0.1
Resolution of process data acquisition	μm	2.2
Resolution of force	N	0.1
Power supply (V AC / 50 – 60 Hz)	V AC $\pm 10\%$	120 – 240

Technical Data		SmartGuard 602
Opening stroke, programmable	mm	up to 160
Speed closing	mm/s	up to 500
Speed opening	mm/s	up to 1000
Dimensions W x H x D	mm	357 x 735 x 380
Weight	kg	36

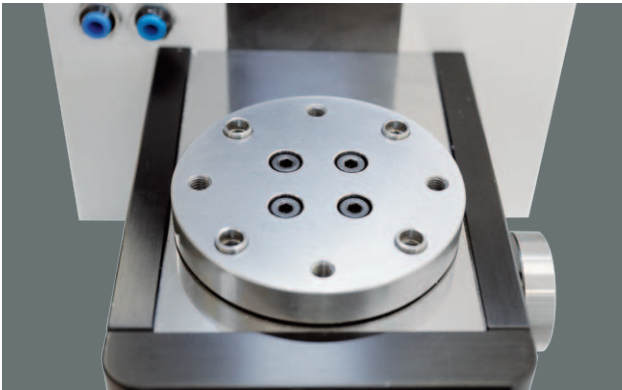
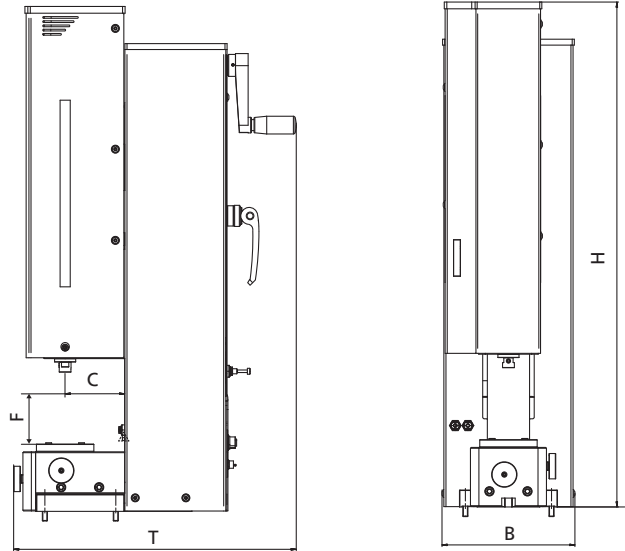

Technical Data	XY slide table in the press table
Adjustment Range	Fine adjustment for alignment optimization ± 0.5 mm 1/100 mm

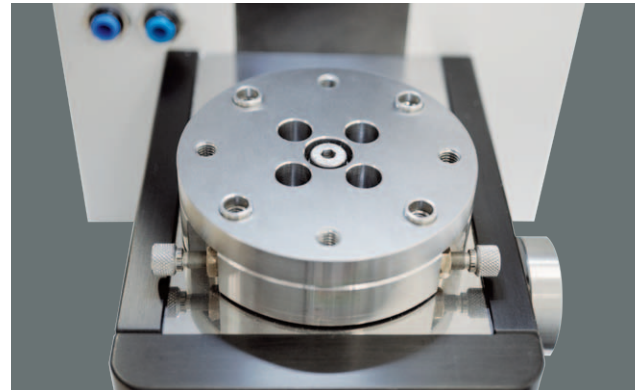

Technical Data	Turntable (Option)
Diameter	68 mm
Mounting thread	8 x TK55 M5
Centering sleeves	4 x 7^{H7} mm
Adjustment range	$\pm 10^\circ$, fine adjustment for alignment optimization 0,01°

SCHMIDT® ServoPress/TorquePress

Superior Control Functionality

Attaching a ball screw to a servo or torque motor isn't enough to produce perfect assemblies. Key to consistent pressing results is having a control that communicates in a fast and accurate manner with the motor's drive.

To achieve this, the drive, measuring unit and controller must be fully integrated. This is exactly what the **SCHMIDT® ServoPress** and **TorquePress** systems provide.

SCHMIDT® ServoPress and **TorquePress** modules with **PressControl 700** or **7000** provide:

- True closed-loop force and position control
- Rapid approach of target force or position with no over-shoot, even during dwell times.
- Positioning repeatability of 1 micron under constant conditions
- Adjustable control parameters
- Standard operation profiles for pressing to position, force, delta stroke, slope or external signal with no special programming required
- Pre-set and optimized acceleration/deceleration values
- Graphic display of Force/Time and Stroke/Time facilitates cycle time optimization

Key characteristics:

- Integrated measurement technology (200Hz measuring frequency)
- Backlash-free stroke measurement
- Zero side load force measurement
- Digitalization of process signals right at the module, making the system impervious to EMI.
- Complete closed loop control system via the **SCHMIDT® PressControl 700 / 7000**
- Optimized PLC for press control
- Software based PLC with integrated CNC for rapid signal processing

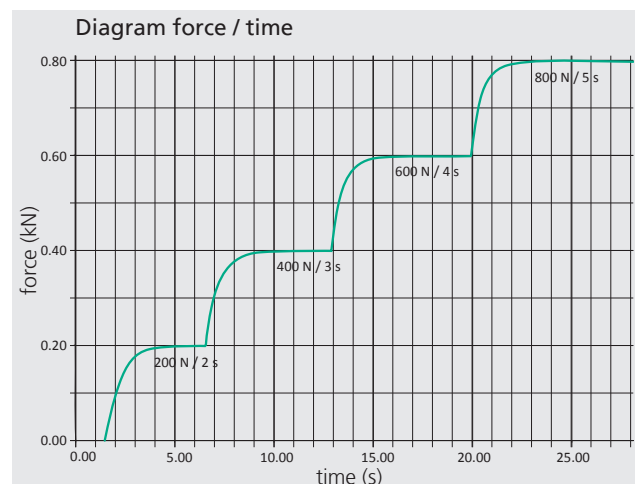

SCHMIDT® TorquePress

Compact, with high efficiency and hollow shaft motor

In addition to the ServoPress series, the **SCHMIDT® TorquePress** has a number of special features. Among other things, a hollow-shaft torque motor is used, which enables very high press forces with a very high motor torque without additional mechanical transmissions.

Compared to other electric presses, the noise level remains remarkably low under all load conditions. The spindle nut, which is driven directly without the use of additional gears, enables very high levels of efficiency. Thanks to the hollow shaft motor, the **TorquePress** is particularly compact and enables short overall lengths.

SCHMIDT® TorquePress are EC type-tested in connection with the safety technology options **SmartGate**, **SmartGuard** and **light curtain** and optionally with the particularly economical one **2-hand operation** .

Nominal force of module available

- 100 % of the time
- At any ram position
- For any duration
- Maximum force available in S3 Mode

Direct ram stroke measuring system

Precision sensor and scale integrated into the press module for direct ram stroke measurement. Tied directly to the PLC/CNC of the system for positioning based on ram location.

- Micron level positioning repeatability thanks to high resolution
- Compression compensation under full load
- Correction of ball bearing pitch inaccuracies
- Temperature related material expansions/contractions do not impact measuring results
- High resolution position feedback for process monitoring

Integrated load cell

Load cell tied into the control of the system to provide:

- True closed loop force control of the ram movement.
- No overshoot of the programmed force
- A constant force regardless of part / environment / system changes.
- True force feedback for process monitoring

System Protection

- Automatic spindle lubrication system
- Overload protection clutch
- Active cooling and thermal monitoring of electronic and mechanical components
- Current limiter

Maintenance friendly

- Automatic spindle lubrication system
- Integrated used grease depot
- No filters
- Plug-and-play module recognition

Efficiency

TorquePress 560 is equipped with brake energy recuperation technology.

What does this mean for you?

- Highest degree of efficiency
- Maximum operational availability
- Highest reliability



TorquePress 520



TorquePress 560

SCHMIDT® TorquePress

With force outputs from of 20 kN to 100 kN

Press type		TorquePress 520	TorquePress 560
Force F max. S3 25 %, 20 s	kN	20	100
Force F 100 % continuous run	kN	10	50
Ram stroke	mm	250	300
Ram speed	mm/s	0 – 260	0 – 200
Resolution position control	µm	<1	<1
Resolution PDA stroke	µm	4	4.6
Resolution PDA force	N/inc	6.25	30
Power supply (V AC / 50 – 60 Hz)	V AC ±10 %	3 x 400 – 480	3 x 400 – 480
Frame dimensions			
A	mm	1102	1399
G	mm	30	39
B	mm	315	288
D	mm	160	304
U	mm	60	60
Weight approx.	kg	95	230
Dimensions of press module with frame SH2/SB2/SL6	mm	1664 / 300 / 568	2325 / 390 / 758
Throat depth with frame C	mm	160	160
Working height with frame F	mm	340	787
Table bore D	∅	40 ^{H7}	40 ^{H7}
Weight with frame approx.	kg	127	552
Ram dimensions			
Ram P	mm	∅ 50	∅ 60
Ram bore Q	mm	20 ^{H7}	20 ^{H7}
Ram bore depth R	mm	50	50
Tool weight max.	kg	≤25	≤100

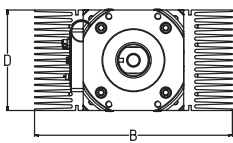

TorquePress 520

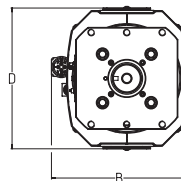
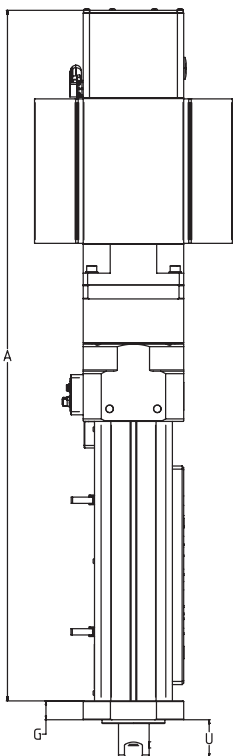

TorquePress 560

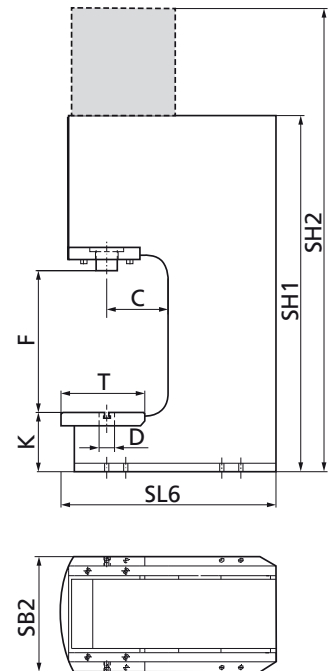
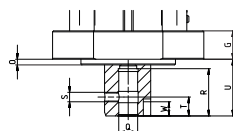
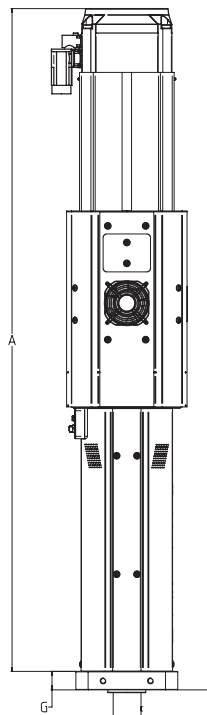

Detailed dimensional drawings can be downloaded:
www.schmidttechnology.com

Dynamic Bend Up Compensation

In order to achieve assembly requirements in the 1/100 mm range, compensation of the system yield is required. Work piece, tooling and machine are elastically deformed by the varying forces induced during the pressing process. Once the operation is complete and the press force is removed, this deformation disappears. The result is that the assemblies are not joined to their programmed dimensions. This yielding effect makes it impossible to produce high precision joints regardless of a systems positioning accuracy.

First, a complete process representation of the force characteristic in loaded and unloaded state is necessary so that the system can carry out the required compensation.

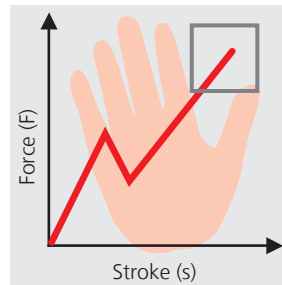

Conventional procedures end in the block position – but the process is not finished yet. The system is under force.

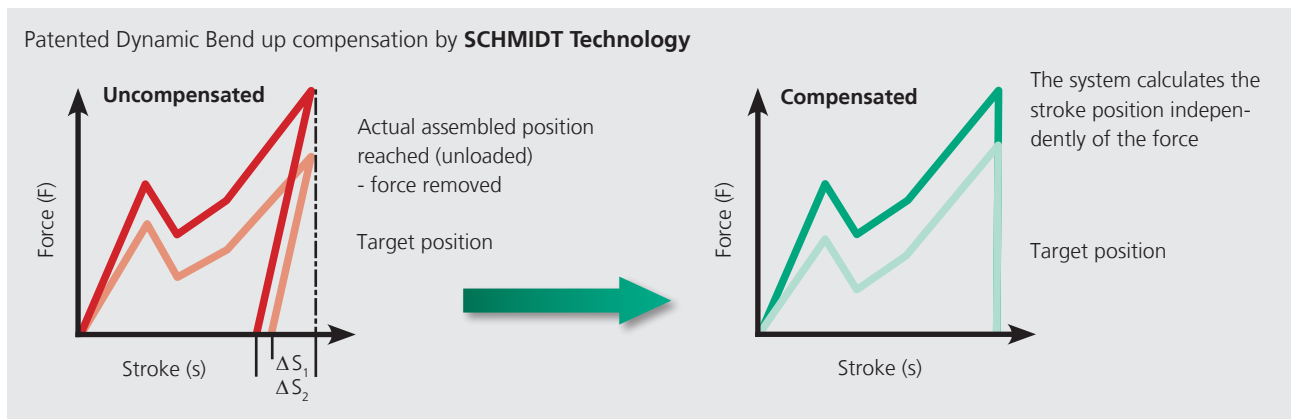

In typical applications, the force required to complete an assembly varies up to 40 % from part to part. When freely positioning, such as without a positive stop, the press ram extends to the same target position, regardless of load. But a closer inspection of the completed assembly and the force/distance curve generated, shows that the final pressed position will vary due to the

forces in the operation. (figure 1) In order to overcome this effect, **SCHMIDT® ServoPress/TorquePress** systems compensate dynamically to the changing forces. This compensation allows for the assembly to be pressed to the target position, regardless of force (figure 2)

- The **SCHMIDT® ServoPress/TorquePress** system determines easily and precisely the system elasticity and compensates it dynamically in real time
- Only with dynamic bend up compensation, the end position can be reached to an accuracy of the 1/100 mm range
- Free positioning with compensation of the system elasticity is more accurate than pressing on effect tool stop
- Dynamic bend up compensation does not reduce the process speed
- Dynamic bend up compensation in connection with other intelligent functions, such as offset of tolerance data, has been patented

Example: Press in a Pin in a Bushing

The elasticity of an assembly depends on the equipment, process and the component geometries. This effect becomes significant for assemblies with which the assembly forces of the individual components differ strongly from one another. This can particularly be seen in the example shown.

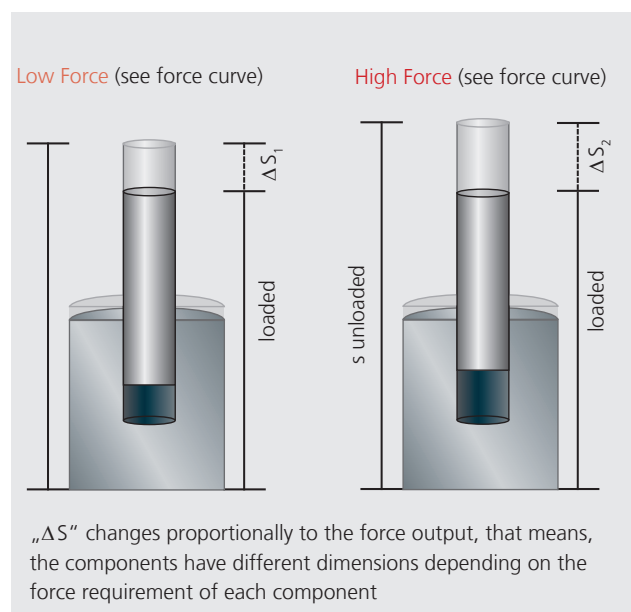

SCHMIDT® PressControl

Machine control units

SCHMIDT® PressControl 75, 700 and 7000 are the latest generation of controls, which allow the design of modern production processes – from the single workstation to complete automation. You benefit from our knowledge in:

- Safety technology – EC type approved machines
- Process measurement technology – simultaneously measuring while processing
- Process documentation

The control systems have the following features:

- Efficient due to intuitive user interfaces on touch / multi-touch screen
- Fast and safe setup of processes in an easy-to-read window, simple parameterization for manual ram movement and transfer of the actual parameters force and path to the motion blocks (teach-in) for the PressControl 700 and 7000 controls in combination with ServoPress/TorquePress/ElectricPress
- The integrated PLC allows the control of additional inputs/ outputs or sensors/actuators and thus the application-specific set-up of the workstation or system
- The integrated measurement data acquisition is insensitive to interferences (EMC). This results in a high measurement reliability of the entire system
- With the integrated safety technology, the entire system becomes an EC type-approved single workstation
- Service functions enable simple and efficient maintenance
- Guarantee of complete process documentation with clearly traceable component assignment

SCHMIDT® PressControl 75



SCHMIDT® PressControl 7000 RT



SCHMIDT® PressControl 700



SCHMIDT® PressControl 7000 HMI



SCHMIDT® PressControl 75

Compact functionality

Highly compact yet multifunctional **SCHMIDT® PressControl 75** available for these press systems:

- **SCHMIDT® ElectricPress**
- **SCHMIDT® PneumaticPress**
- **SCHMIDT® HydroPneumaticPress**

It's easy and intuitive touchscreen allows for quick and efficient process set-up or change-over. Process specific data can be stored in up to 24 datasets.

The **SCHMIDT® SafetyModule** allows the design of single workstations with safety technology that meets the latest global standards for two-hand cycle initiation, guarding or light-curtain protection.



Technical Data	
Supply voltage	24 V DC
Current	< 3 A
Operating temperature	0 – 40 °C
Protection class	IP 54
Interfaces	<ul style="list-style-type: none"> ■ CANopen for PRC -Gateway or CANopen Compact Box IP 2401
Electrical connections	All connections are pluggable
Display	<ul style="list-style-type: none"> ■ 2.8" touch screen ■ Process information
Operation	<ul style="list-style-type: none"> ■ 4 function keys ■ 3 languages, switchable
Modes of operation	<ul style="list-style-type: none"> ■ Two-hand release with SafetyModule ■ Light curtain with SafetyModule ■ Start button for operation without SafetyModule ■ Workpiece control ■ Activation of sliding table ■ Return stroke initiation with external signal ■ Blow-out/blow-off
Operating functions	<ul style="list-style-type: none"> ■ Piece- or preselection counter ■ Set-up mode ■ BDC dwell time ■ User Management
Dimensions	90x120x60 (hxxwx d)
Mounting	Fastening screws, optional magnet holder

>>press parameter<<
presstime endposition 0,5 s
>>counter<<
preselect counter off
preselect quantity 10 pcs

Data input

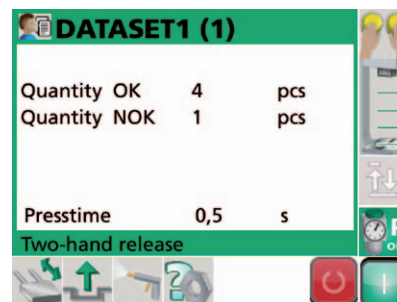

Data output

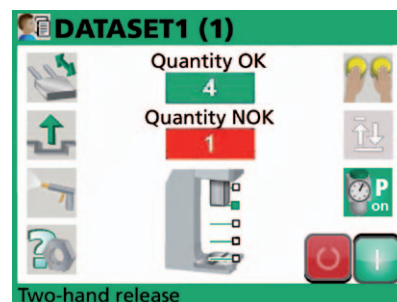

Data output

SCHMIDT® PressControl 700

"All in one" control and visualization for the single workstation

The **SCHMIDT® PressControl 700** for single workstations is used for the control and monitoring of pressing and joining processes. In addition to precise assembly tasks, the fast acquisition of extensive process data and bidirectional data exchange is becoming more and more important.

The **SCHMIDT® PressControl 700** real-time controller communicates with the process components via the high-performance and fast field bus EtherCAT with a transmission rate of 100 Mbit/s and a transmission speed of 0.5 ms. With this the press control meets the requirements for fast processing of large data volumes. The leap into other fieldbus worlds is realized by using optional fieldbus gateways.

Process visualization takes place directly on the PressControl 700. Via the Ethernet interface, the control communicates with MES systems and external PCs as well as PRC DataBase and PRC FileX-change software.

The press control system is optimally designed for **SCHMIDT® press systems**. Thanks to the integrated PLC, process visualization, the best possible compatibility and performance is achieved. All components are tested and matched to each other in the network and are therefore ready for immediate use.

User Surface

- 10.1" Full HD multi-touch-screen
- setup and setting of parameters via "drag & drop"
- compact display of the entire process in the home view
- individual sizing of the process windows (splitter function)
- language switchable

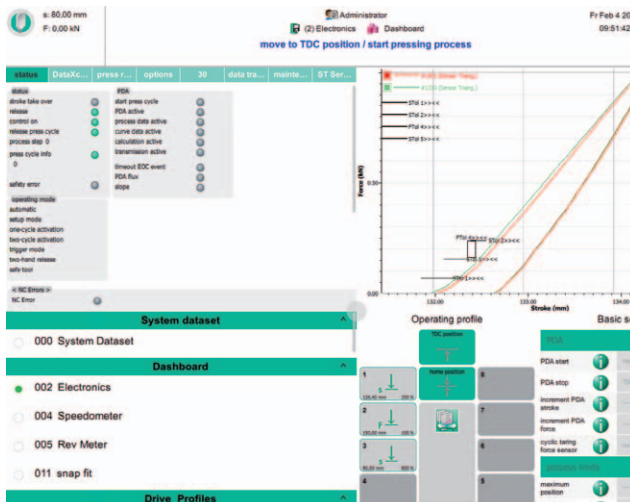

Technical Data

Industrial PC	Intel E3990 processor 2 GB main memory 16 GB on-board Flash (eMMC) 4 GB CFAST Linux operating system
Interfaces	2 x USB 2.0 2 x USB 3.0 1 x Ethernet, M12 (LAN1) 1 x Ethernet, M12 (LAN2) 1 x EtherCAT-P, M8
Power supply	24 V DC (EtherCAT-P)
Current consumption	max. 1,3 A
Weight	ca. 1,9 kg
Ambient Temperature	0 °C ... +40 °C
Humidity	0 ... 90 % relative humidity (not condensing)
IP Rating	IP 54

SCHMIDT® PressControl 7000

Compact system control for intelligent process control

The **SCHMIDT® PressControl 7000 RT** for single workstations is used for the control and monitoring of pressing and joining processes. In addition to precise assembly tasks, the fast acquisition of extensive process data and bidirectional data exchange is becoming more and more important.

The **SCHMIDT® PressControl 7000 RT** real-time controller communicates with the process components via the high-performance and fast field bus EtherCAT with a transmission rate of 100 Mbit/s and a transmission speed of 0.5 ms. With this the press control meets the requirements for fast processing of large data volumes. The leap into other fieldbus worlds is realized by using optional fieldbus gateways.

Process visualization takes place directly on the PressControl 7000. Via the Ethernet interface, the control communicates with MES systems and external PCs as well as **PRC DataBase** and **PRC FileXchange** software.

The press control system is optimally designed for **SCHMIDT® press systems**. Thanks to the integrated PLC, process visualization, the best possible compatibility and performance is achieved. All components are tested and matched to each other in the network and are therefore ready for immediate use.

SCHMIDT® PressControl 7000 HMI

- 21.5" Full HD multi-touch screen
- Multi-axis applications can be visualized
- Setup and setting of parameters via "drag & drop"
- Installation of optional software tools such as **SCHMIDT® PRC DataBase** or **PRC FileXchange** is prepared



Technical Data PressControl 7000 RT	
Industrial PC	Intel E3990 Processor 2 GB main memory 16 GB on-board flash (eMMC) 4 GB CFAST Linux operating system
Interfaces	1 x display port 2 x USB 2.0 2 x USB 3.0 3 x Ethernet, RJ45 (LAN1 via integrated switch on 3 ports) 1 x Ethernet, RJ45 (LAN2) 1 x EtherCAT, RJ45 Universal Fieldbus, integrated compartment for installation
Power supply	24 V DC (via 3-pin plug)
Current consumption	1 A
Weight	approx. 0.73 kg
Ambient temperature	0 °C ... +65 °C
Storage temperature	-20 °C ... +70 °C
Humidity	0 ... 90 % relative humidity (not condensing)
IP Rating	IP 20; PressControl 7000 RT placed in electrical cabinet

Technical Data PressControl 7000 HMI	
Industrial PC	Intel i5-7xxx Processor 64 GB CFAST operating system 512 GB HDD data memory Operating system Windows 10
Monitor	21.5" full HD monitor (1920 x 1080) with capacitive multi-touchscreen
Interfaces	1 x HDMI 2 x USB 2.0 2 x GBit Ethernet, M12, X-coded (LAN1, LAN2) 2 x integrated loudspeaker
Power supply	24 V DC (via 4-pin M12 plug, T-coded)
Current consumption	2 A
Weight	approx. 9.5 kg
Ambient temperature	0 °C ... +40 °C
Storage temperature	-20 °C ... +60 °C
Humidity	5 ... 90 % relative humidity (not condensing)
IP Rating	IP 54
Assembly	VESA 75

User surface for professional assembly

For PressControl 700 and 7000

The user interface for professional assembly is installed in the **SCHMIDT® PressControl 700 and 7000**. The functionality has been developed specially for assembly operations with immediate reaction in the process.

The following functions are available

- process visualization
- process data management
- development tool (PLC editor)
- **SCHMIDT® PRC DataBase, PRC FileXchange, PRC OPC** optional

Process Monitoring

- high graphical curve resolution for detailed view of curve segments
- three graphic displays; force/stroke, force/time and stroke/time for process analysis and optimization
- extensive tool library
- result visualization OK/NOK (green/red)
- tolerance observers

Process Output

Actual system statuses are displayed both text-oriented and graphically and thus enable a transparent process overview for quick analysis and troubleshooting.

Software Options

The comprehensive software packages for process data management and process optimization can be activated individually and specifically stored in data sets.

Characteristics

- easy and fast setting of parameters for the processes
- definition of data sets and motion profiles by parameter setting
- process optimization by switching the process display (F/s, F/t, s/t)
- easy definition and evaluation of processes via quality observers
- 12 QA observers can be defined as F/s windows or stroke tolerances as required
- safe detection of bad parts (NOK)
- Clear documentation and part assignment
- software PLC to freely program sequences
- service functions for diagnosis and system updates

User Interface SCHMIDT® PressControl 700

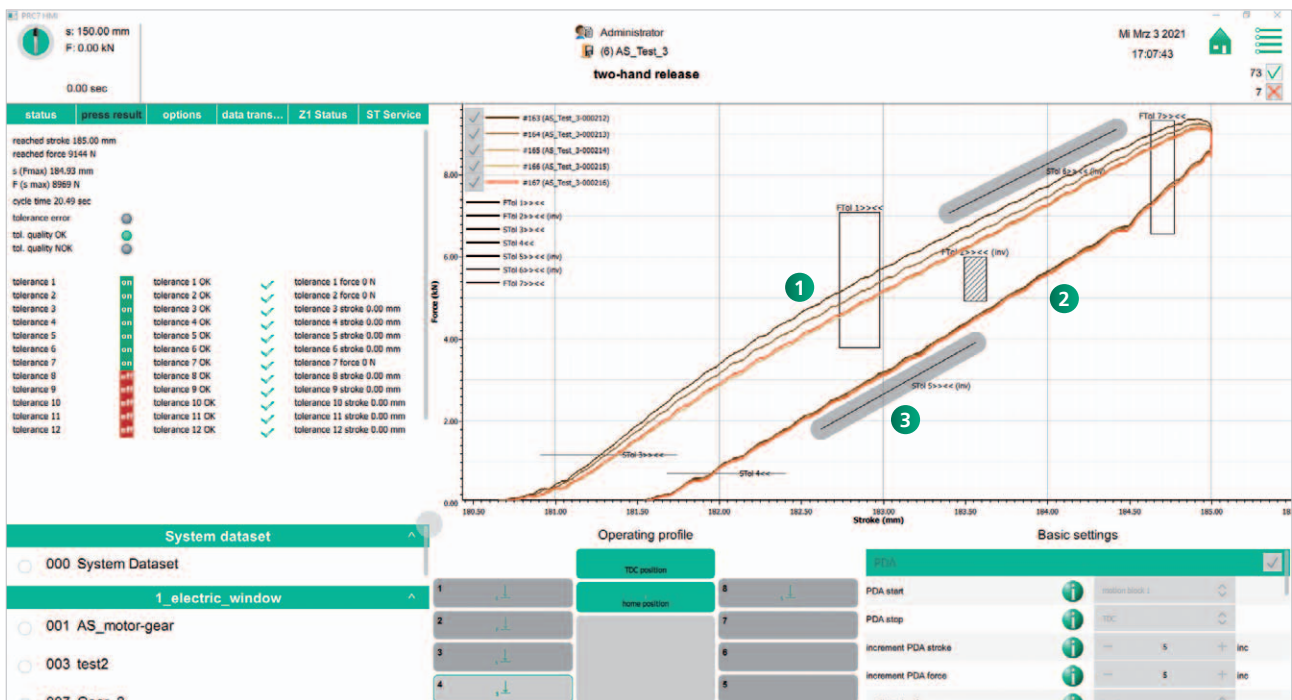

1 + 2 All tolerances can also be used inverted (blocking ranges) 3 Stroke tolerances can be adapted to curve gradient

SCHMIDT® ServoPress/TorquePress

Driving profiles and applications

SCHMIDT® ServoPress / TorquePress enable simple configuration of the driving profiles with motion blocks. In order to realize a quick setup, different standard driving profiles are available.

Experience shows that these standard driving profiles and combinations cover most applications. Up to 8 motion blocks can be combined as desired.

Positioning to "stroke"

Normal driving profile, typically combined with bending compensation.

Closed loop "force" control

For processes in which the force achieved is a measure of the process quality, e.g. material compressing processes.

Driving on touch force and "delta stroke"

For processes in which component tolerances must be reached. The press scans the surface and presses in to a specific differential dimension as soon as the defined force is reached.

Driving on "Force increase"

The return stroke is initiated at a defined force increase (slope)

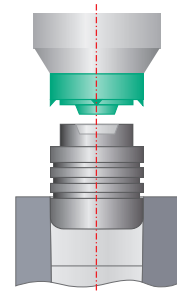
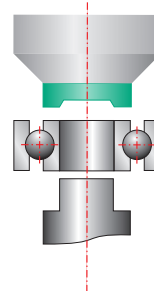
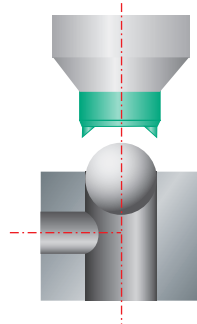
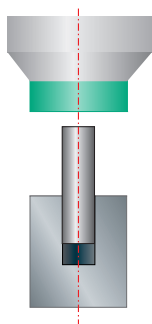
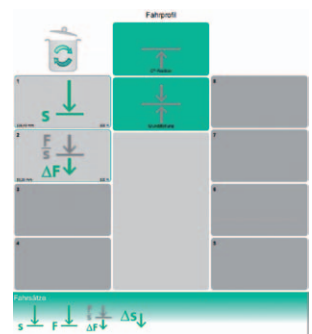
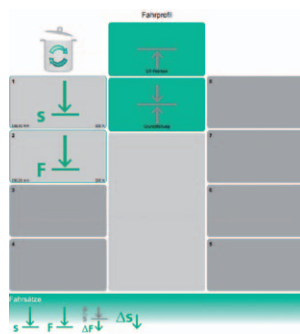
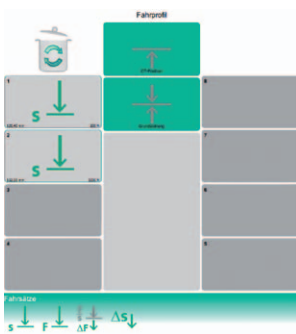

Pressing until reaching a specified position leads to precise results in connection with bend up compensation.

Plugging blind bores – a sphere is pressed in and crimped. Force output correlates to material displacement to determine density and retain force independent of stroke or the safe seating of bearings on shafts

Pressing to a functional dimension with force-controlled touching of the body edge and subsequent relative movement (delta stroke)

Pressing in expanders or crimping cable shoes. The sealing or holding function depends on the correlation of force and displacement.

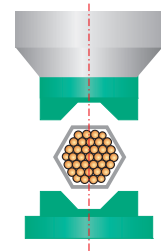
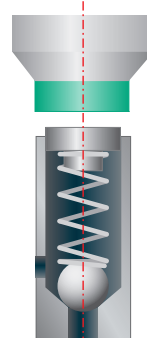
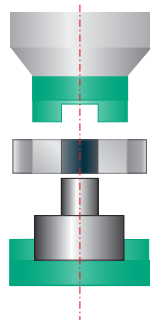
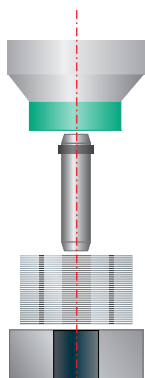

Visualization and process analysis for PressControl 700 and 7000

Visualization user surface

Important parameters for assessing the quality of press fits are the press force and the press stroke. The data of these measured variables are recorded during the process and displayed by the software as a force-displacement curve F/s or F/t or s/t .

For quality assurance of the joining process, freely definable tolerances are provided in the form of force-stroke windows and stroke tolerances. With the help of these criteria, the quality-critical areas can be precisely monitored. If the tolerances are not adhered to in the monitored curve areas, appropriate application-specific reactions can take place (e.g. selection measures).

Tolerance criteria can be created very easily and progression curves can be displayed exactly. Not only the working stroke but also the return stroke are important for the evaluation of the curves. The high resolution of our measuring systems allows a large number of measuring points, which are necessary for a process-reliable evaluation. Integrated zoom and measurement functions allow detailed statements on the joining processes.

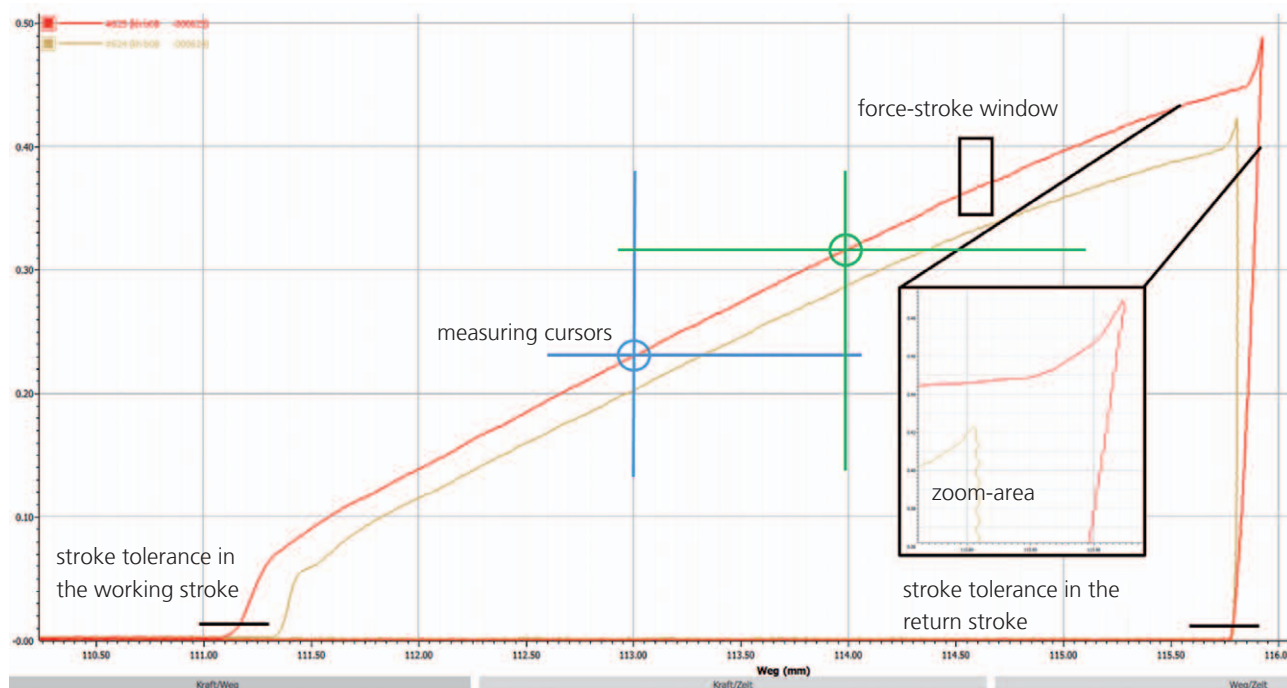

Process analysis – graphic display force over stroke

SCHMIDT® MoveTol

Offset of tolerance, data software for PressControl 700 and 7000

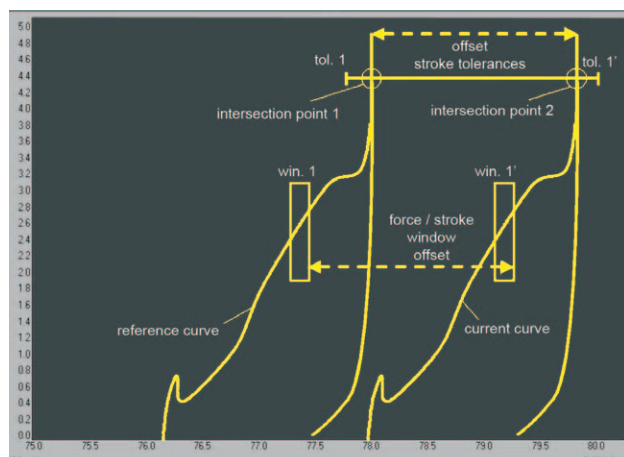

Assembly parts are subject to certain manufacturing tolerances. Height deviations of the parts result in an offset of the curves in the curve window. The curves of the parts with larger tolerance deviations can then lie outside the created tolerance limits and are declared as bad parts.

The height tolerances of the parts can be taken into account with the "Tolerance data offset" function. The defined tolerance windows and stroke tolerances are shifted by the distance to a reference position. The good/bad evaluation is then performed.

Offset of the tolerance data is relative to freely selectable references.

SCHMIDT® Software Tools

For Archiving, Evaluation, and Control.

SCHMIDT Technology offers modular software tools to meet the diverse requirements in data management.

- SCHMIDT® PRC OPCUA
- SCHMIDT® PRC DataXchange
- SCHMIDT® PRC DataBase
- SCHMIDT® PRC FileXchange

These include options in the areas of system control, data storage and exchange, visualization, and analysis. This allows for the implementation of a wide range of requirements in quality assurance, statistical process control, traceability, and optimizing production processes.

SCHMIDT® PRC OPC UA

Ethernet-Based Data Exchange, Platform-Independent, Secure.

Our OPC UA server offers all process data (such as working parameters, process results, PLC variables, etc.), which can be subscribed to by an OPC client individually.

These subscribed data form the basis for higher-level data management systems such as SCADA, MES, and others. Bidirectional data transfer also enables process adjustments, for example, based on process outcomes.

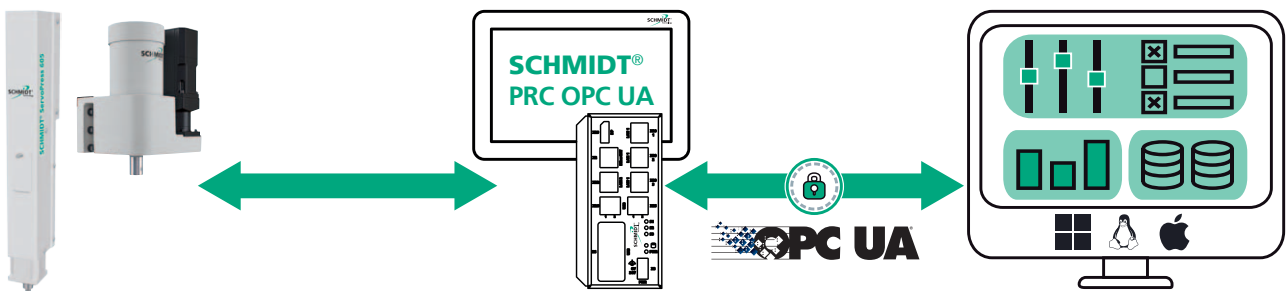

SCHMIDT® PRC DataBase

Database software for PressControl 700 and 7000

SCHMIDT® PRC DataBase is an optional software for the modular control system SCHMIDT® PressControl 7000 or SCHMIDT® PressControl 700. The database software is used for storing and analysing the data of the control system – process specifications and process results – particularly under quality assurance aspects.

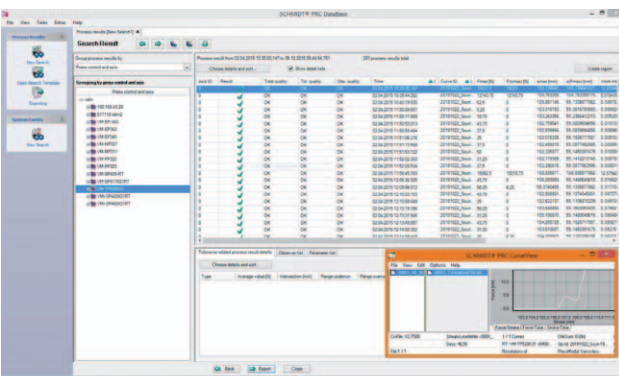
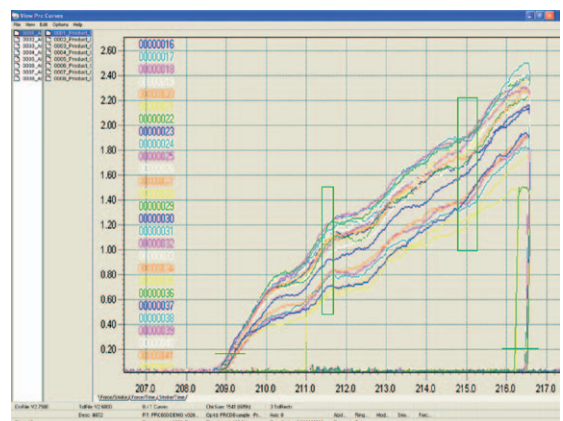

Characteristics

- Documentation
- Analysis
- Quality assurance
- Traceability
- Data export in CSV format
- Q-DAS interface with certification

SCHMIDT® PRC FileXchange

Safe exchange of process data

In addition to data exchange within an automation solution via Fieldbus, data exchange can also be performed via data files. For every press process all relevant process results, tolerances, observer, and parameters are written into a file whose format and content can be configured via an intuitive user interface.

The following output formats are available:

- Microsoft Excel (CSV)
- Q-DAS
- SCHMIDT® CRV/TOL
- XML

The transmission of production data is synchronized from PressControl to PC (File System). That means if the connection between PressControl and PC is interrupted the process is stopped, the event is recorded. Once the connection is re-established the data of the last press process will be transmitted again.

It is also possible to import default values for press processes from a configuration file. A production range which comprises several different products can, for example, be managed via standard PC application and thus be used as production database.

The respective product-specific configuration file can be created by the SCHMIDT® PressControl HMI for all relevant process parameters and transferred to the customer's management software via xml file.

export

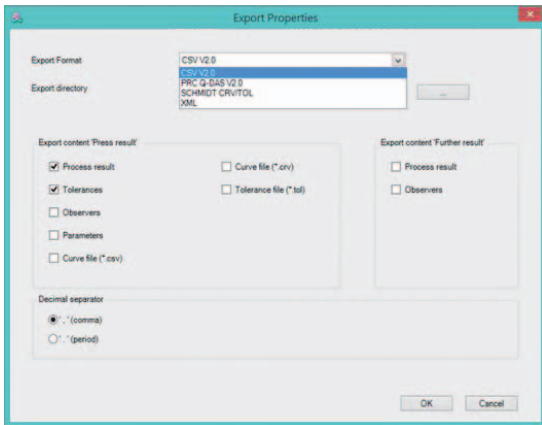

Configuration of output format and content

Storage of the results in a dedicated directory

▶

Transfer to the target system for evaluation and further processing

visualization example

user

import

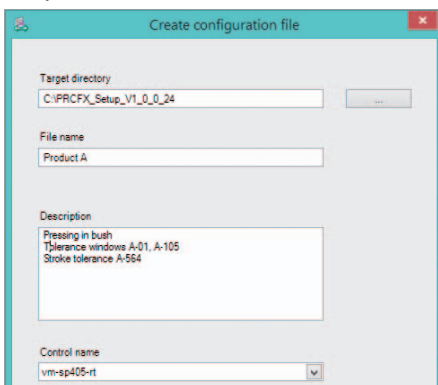

Generating configuration files
(Parameters for particular joining processes)

Management of product configuration files

▶

Transfer of process parameters via xml-file

user

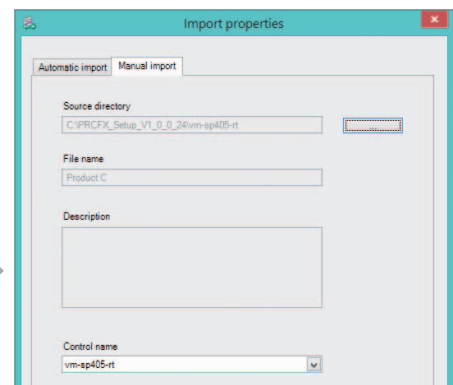

Automatic or manual import into the press control

SCHMIDT® PRC DataXchange

Bi-directional data exchange with higher-level controls

The **PRC DataXchange** interface is available for communication between a **SCHMIDT® press system** and a higher-level control system.

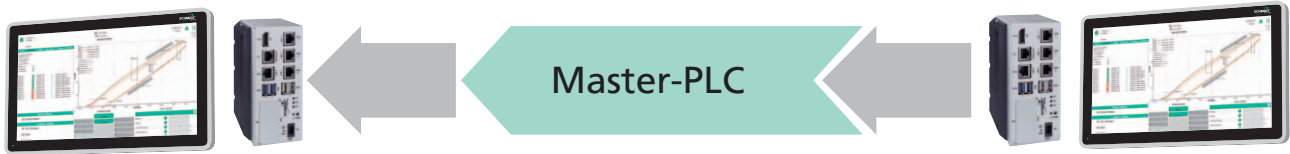

DataXchange Input

Parameter-Transfer to PressControl

Dynamic adaptation of processes

- Control type (force, stroke, ext. signal, relative position, ...)
- Position
- Speed
- Force
- Motion block change (stopping, flying, ext. trigger signal)
- Dwell time

DataXchange Output

Data-Transfer to Master PLC

for connection to MES and ERP systems

- Reached position
- Reached force
- Actual values position and force
- Curve results
- Tolerance values
- Status signals of the system
- Error states
- Press axis information

SCHMIDT® PRC OpenFieldBus

OpenFieldBus allows a completely custom specification and programming of driving profiles and sequences by a master control as well as the bidirectional transmission of all relevant data. To implement individual requirements in the press process, the complete command set can be accessed. At the same time, the advantages of the integrated force-stroke monitoring and control of the press system with all evaluation functions can be utilized

Characteristics

- Access to the entire command set of the **SCHMIDT® press control**
- Transmission of process results to the master controller
- Individual definition of joining processes, driving sets and data exchange

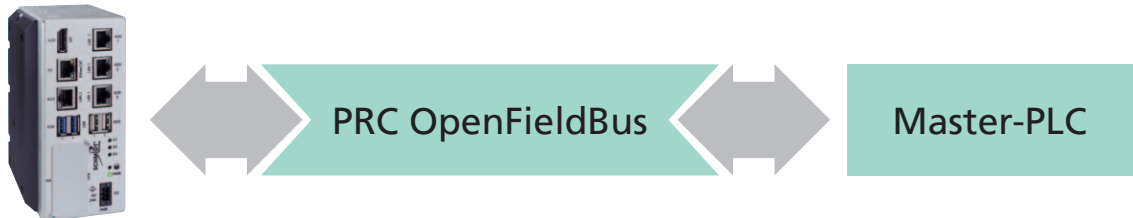

SCHMIDT® Hardware-Tools

Proven components for system integration

SCHMIDT® PressControl 700 and 7000 communicate with higher-level control systems via a standardized interface program. All relevant system states as well as bad part detection performed by simple signal exchange from one control to the other.

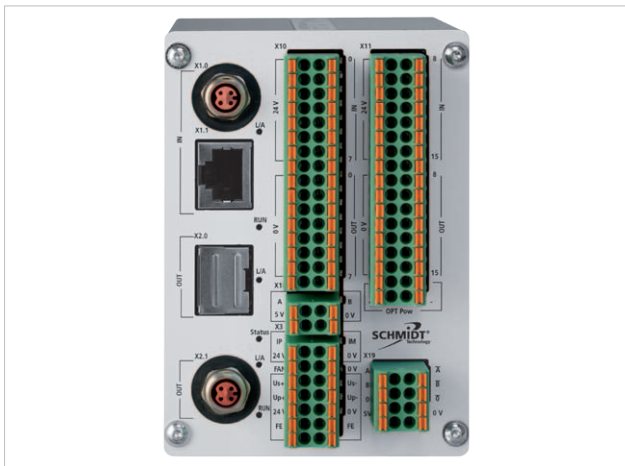

SCHMIDT® PRC Gateway

- EtherCAT-connections to PressControl (Master) und PDA (Slave), with 24 V-power supply via EtherCAT-P
- 24 V-Interface with 16 inputs and 16 outputs (up to 0.5 A / output)
- short circuit proof and overload protected
- status-LEDs for EtherCAT-Bus and In- / outputs
- encoder-interface
- interface for external hand wheel as handheld
- top-hat rail mounting

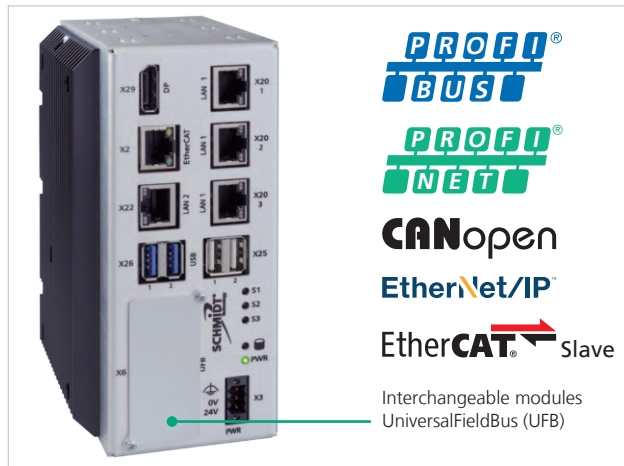

Communication via fieldbus-systems

All common physical interfaces can be used for signal exchange with the automation environment.

- interchangeable modules UniversalFieldBus (UFB)
- further fieldbus interfaces via external gateway
- USB



External handwheel as handheld

for **SCHMIDT® PressControl 700 and 7000 RT** in combination with **SCHMIDT® ElectricPress** with process monitoring or **SCHMIDT® ServoPress/TorquePress**, connection via **SCHMIDT® PRC Gateway**



EtherCAT-P Compact Box

- 8 digital channels, usable as inputs or outputs
- signal connection by screwing via M8 plug connector
- power supply (24 V) via EtherCAT-P
- load currents of the outputs up to 0.5 A
- total current of all outputs 3 A

SCHMIDT® PressControl

System architecture

SCHMIDT® PressControl does work as a system control and takes over the process monitoring. The hard- and software components forming a system concept with real time characteristics. This is guaranteed by a system architecture with CANopen fieldbus. Press force monitored SCHMIDT® ManualPress,

SCHMIDT® (Hydro-)PneumaticPress, SCHMIDT® ElectricPress or SCHMIDT® ServoPress/TorquePress will be activated via fieldbus. The collected measuring data as well as in-/output data will be exchanged by the fieldbus.

SCHMIDT® PressControl 700

system architecture

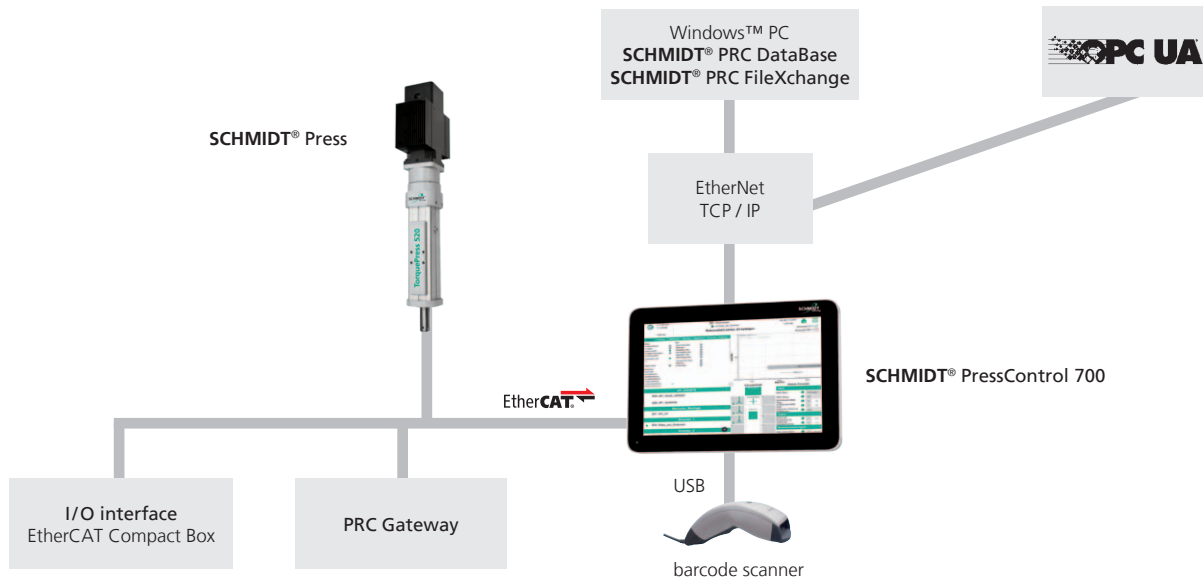

SCHMIDT® PressControl 7000 RT with 7000 HMI or 700 HMI

system architecture

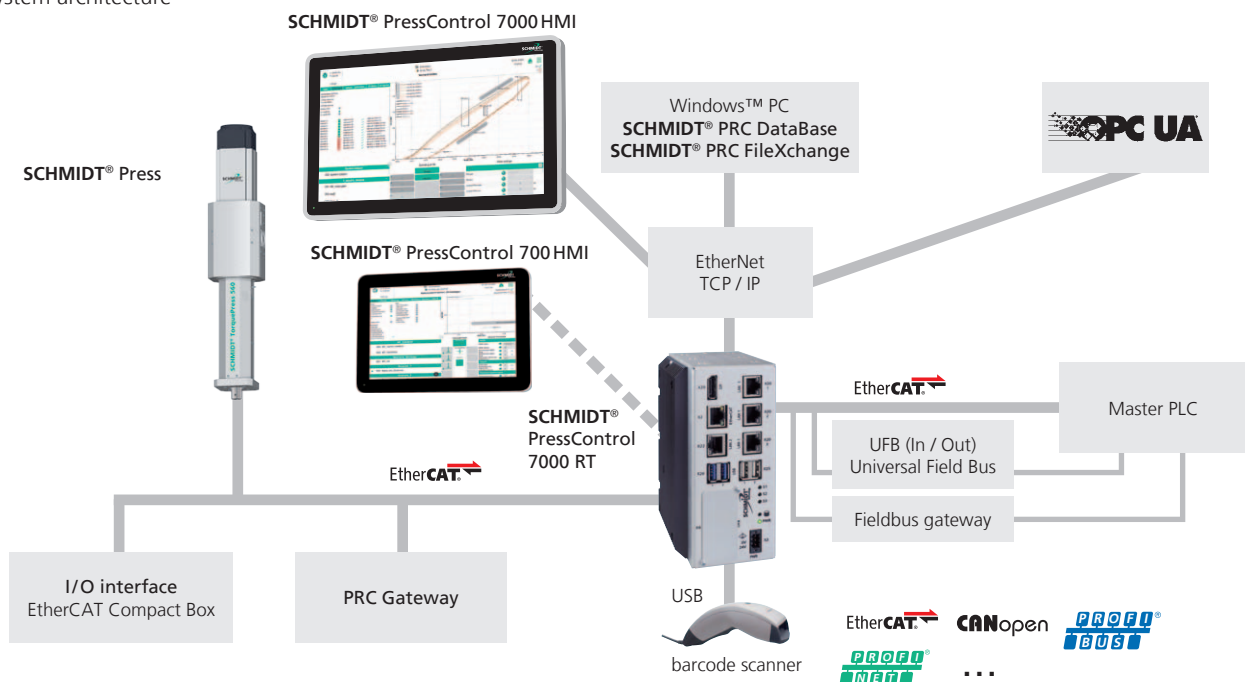

SCHMIDT® Single Workstations

Ergonomics with certified safety technology

SCHMIDT® workstations are supplied ready to use with certified safety technology and corresponding operating elements. Depending on customer requirements, workstations can be equipped with the following safety elements:

- SCHMIDT® SmartGuard protection cover
- SCHMIDT® SmartGate protective housing with automatic doors
- light curtain
- two-hand safety

The delivery includes:

- Module SCHMIDT® presses mounted on stand or pedestal
- SCHMIDT® PressControl 75 (in two-hand release and light curtain versions), 700 or PressControl 7000 with pendant arm system
- Press base PU 20 / PU 40 in rigid or height-adjustable design, depending on the safety concept optional or as standard

All systems are EC type-approved!

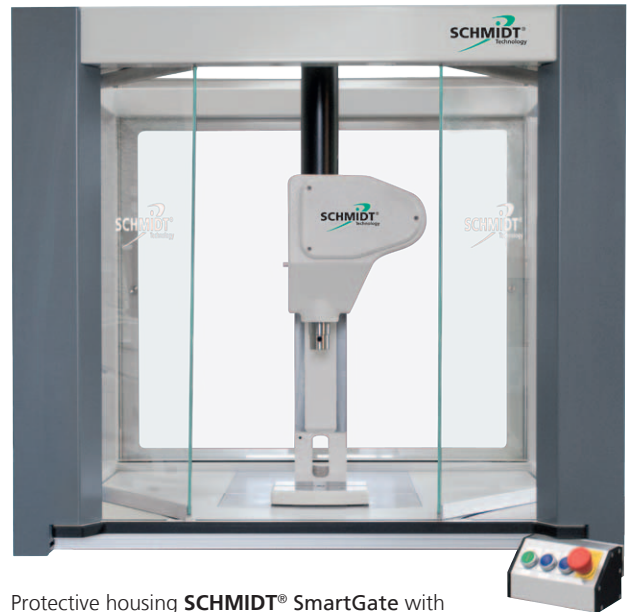

Protective housing SCHMIDT® SmartGate with automatic doors and ElectricPress 345



The protection cover SCHMIDT® SmartGuard with ServoPress 617



Safety concept light curtain with SCHMIDT® ElectricPress 347 and PressControl 700 on a press base PU 20

SCHMIDT® SmartGate

Shorter process cycles and increased safety standards

SmartGate is a protective enclosure with automatic doors. The access to the process area is via two transparent, horizontally guided door elements. Key benefits of SmartGate over other safety concepts, such as light curtain or two-hand systems, are the significant increase in ergonomics and workflow efficiency through reduction of required safety margins and the excellent accessibility of the process space.

SmartGate sets new standards in the field of safety by completely closing off the process area, completely eliminating unintentional third-party intervention or fragmentation. SmartGate is particularly suitable for processes with the risk of splintering due to protection against flying parts or spalling.

When designing SmartGate, we ensured that all surfaces are as easy to clean as possible and that there are no areas where residues or particles can accumulate. High demands on purity and cleanliness, as they occur, for example, in applications in medical technology can therefore be easily met.

SmartGate	
Max. opening width	720 mm
Variable speed	50 – 350 mm/s
Typical opening time	2.2 s
Typical closing time	1.8 s
Noise emission	< 60 dB(A)
Cell size 1	1010 x 883 mm
Cell size 2	1010 x 1049 mm
Protective door	laminated safety glass (VSG)
Safety category	Plexiglass



Characteristics

- Protection of the working area from unintentional intervention
- Splinter protection from chipping of parts
- Visible working space
- Optimization of the safety distances to the complete danger area
- Consideration of quality assurance requirements (NIO behaviour)
- Cycle time and process optimization through programmable opening and closing speed (<2 s)
- Very high energy efficiency due to linear motor drive
- Type approved

SCHMIDT® Safety Technology

Smart safety concept for servo and torque presses

The transparent protection cover entirely encloses the working area during the press process. It thus prevents the user and a third person from getting their hands into the danger area and efficiently protects against the particles or splinters that may be ejected. The distances to the working zone are minimized which considerably improves the ergonomics and the efficiency of the workstations. The high dynamics of the protection cover with numerical control and its variable positioning capability and traversing velocity optimize the process cycle. The smart construction prevents any trap points in the enclosure.

SCHMIDT® SmartGuard is a protective shield for TorquePress 520, TorquePress 560 and ServoPress 605 to 620.

SmartGuard	type	SP 605	SP 616	SP 617	SP 620	TP 520
Variable opening stroke	mm	280	350	410	500	390
Speed opening	mm/s	200 - 1000				
Speed closing	mm/s	200 - 500				
Drive	type	linear motor				
Deep	mm	434	485	573	644	599
Wide	mm	232	286	312	359	343
Height	mm	1018	1111	1440	1840	1640
Material guard	PC	antistatic / transparent				
Electr. safety lock		Ple				



Characteristics

- Protection of the working area from unintentional intervention
- Splinter protection from chipping of parts
- Visible working space
- Optimization of the safety distances to the complete danger area
- Consideration of quality assurance requirements (NIO consideration)
- Cycle time and process optimization through programmable opening and closing speed (<2 s) and the opening height
- Very high energy efficiency due to linear motor drive
- Type approved
- ESD version possible

SCHMIDT® Light curtain

Light curtain with guarding

The light curtain control provides optimum safety to the user. The process area is protected with polycarbonate windows against contact. A light curtain protects the access to the hazard area on the side of insertion. The working process is immediately interrupted and the dangerous motion of the press is stopped. The cycle can be continued automatically after leaving the danger area. In combination with **SCHMIDT® ServoPress**, the light curtain control is the basic version. The press can be activated via the light curtain. Depending on the application, it can be selected between 1-cycle and 2-cycle activation.



SCHMIDT® Two-hand safety

Light curtain with guarding

The light curtain control provides optimum safety to the user. The process area is protected with polycarbonate windows against contact. A light curtain protects the access to the hazard area on the side of insertion. The working process is immediately interrupted and the dangerous motion of the press is stopped. The cycle can be continued automatically after leaving the danger area. In combination with **SCHMIDT® ServoPress**, the light curtain control is the basic version. The press can be activated via the light curtain. Depending on the application, it can be selected between 1-cycle and 2-cycle activation.

Two-hand safety technology

In basic design, **SCHMIDT® PneumaticPress**, **SCHMIDT® Hydro-PneumaticPress** as well as **SCHMIDT® ElectricPress** are operated with **two-hand safety technology**. The user must keep both switches in the activated position. If one switch is released ahead of time, the press stroke is interrupted. This applies to all positions above the automatic stroke takeover that is started from the point where the dangerous closing movement is finished. From the stroke takeover, the stroke is continued automatically.



SCHMIDT® Press Bases

Ergonomic in focus

SCHMIDT® Press Base PU 20 and PU 40 for a safe and vibration-proof installation of all SCHMIDT® Press Systems.

Both press bases are available in two versions:

- Fixed columns with height adjustable from 780 to 1200 mm (30.7" - 47.2")
- Electrically height-adjustable from 725 to 1075 mm (28.5" - 42.3")
 - Infinitely variable parameterisation with PressControl 700/7000
 - Storage of operator-dependent working heights

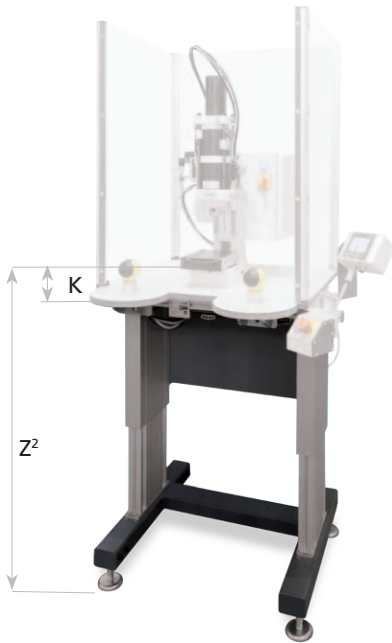

PU 20 with two variable columns

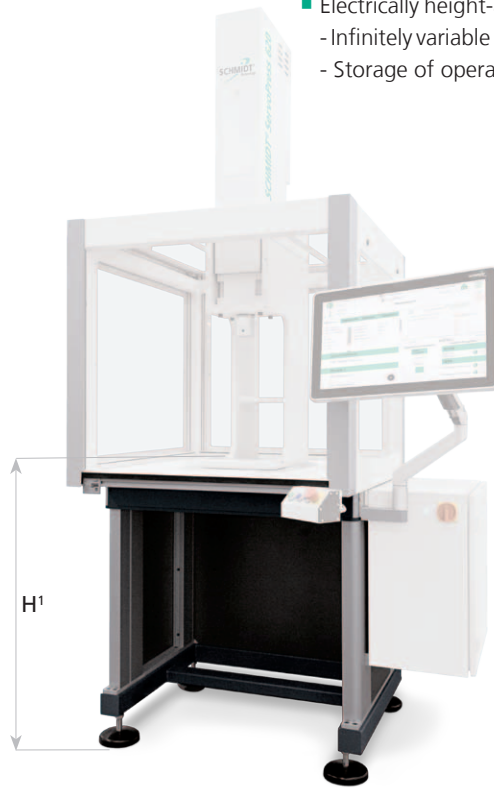

PU 40 with four fixed columns



PU 40 with four variable columns

Technical Data			PU 20 (2 columns)	PU 40 (4 columns)
Fixed columns	H	individually	780 – 1200 mm	780 – 1200 mm
Motorized variable columns	Z	stepless	725 – 1075 mm	725 – 1075 mm
Lifting capacity		kg	600	1200
Width x depth			on request	on request
Foot rest			-	✓

¹⁾ Height H measured from floor space to press table top

²⁾ Fixing dimension Z stand on PU20, resulting height of the press table depends on frame type (see dimension K in the respective press chapters). Example: frame type 3 for press No. 25 K = 60 mm, PU20 (725 mm to 1075 mm) and press table height 60 mm results in total press table infinitely adjustable from 785 mm to 1135 mm

SCHMIDT® Column Gantry

SCHMIDT® Column Gantries used in manual workstations, and automated assembly lines, are suitable for all SCHMIDT® Presses with extraordinary requirements in all working area.

In order to consider the large number of applications and cases, the design is adapted specifically to your requirements. All individual requirements can be taken into account. Short delivery times are realized because of in-house production. Contact us with dimensions (see table), and we can supply you with a proposal.



SCHMIDT® Slide Tables

For efficient production

SCHMIDT® Slide Tables are specially designed for the high forces of press systems and where a position requires high precision against an adjustable stop. It is an economic solution for tall parts and for placement of parts outside of the danger area. They can be mounted, depending on the type, both in longitudinal and lateral positions, and can be adapted for automated processes.

Characteristics

- Force closure due to unique anvil system
- Backlash-free guide systems for consistent smooth running over the entire stroke
- Operator safety due to covering of danger points (no pinch points)
- High reliability due to protection against particle ingress
- Dynamic end-position cushioning prevents hard impacts
- Triggering of the press stroke via adjustable position sensors



SCHMIDT® Slide Table ST 100M longitudinal with handle

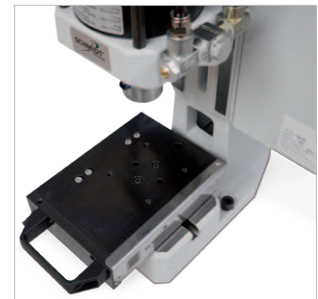

ST 100M / ST 100P

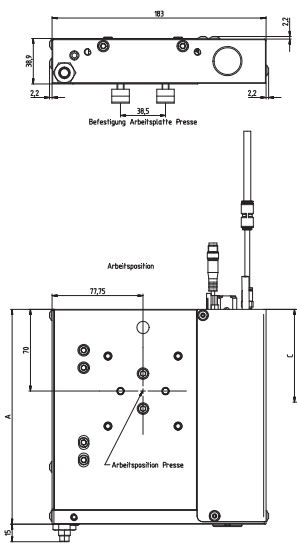

ST 150M / ST 150P

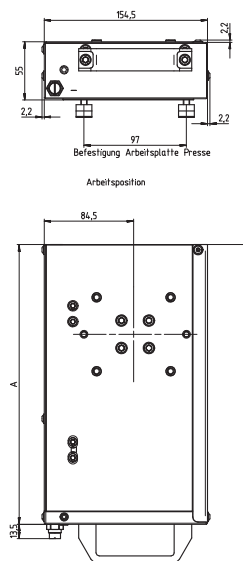

SCHMIDT® Slide Table ST 100M cross mounting with adapter plate for fastening on the fixture mounting plat



Type		ST 100M	ST 100P	ST 150M	ST 150P
Pressure load	kN	100	100	150	150
Max. stroke V1	mm	79.5	80	129.5	130
Max. stroke V2	mm	159.5	160	199.5	200
Repeatability working position	mm	±0.01	±0.01	±0.01	±0.01
Repeatability loading position	mm	±0,2	±0,01	±0,2	±0,01
Dimensions B/H/T V1	mm	142 / 39 / 220	188 / 39 / 211	159 / 55 / 301	159 / 55 / 279
Dimensions B/H/T V2	mm	142 / 39 / 300	188 / 39 / 291	212 / 55 / 271	212 / 55 / 349
Weight V1	kg	3.6	4.2	10.8	12.7
Weight V2	kg	6.9	7.6	11.8	14.1
Max. tool weight	kg	10	10	10	10
Operating mode		manual	pneumatic	manual	pneumatic

SCHMIDT® Slide Table ST 150P, pneumatic operating mode

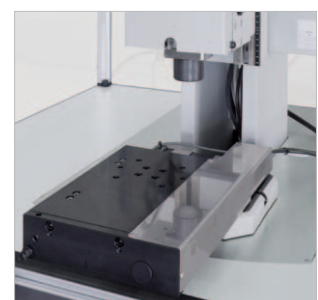

SCHMIDT® Customer-Specific Solutions

Standard 'out of the catalog' products, customized or complete turn key solutions. **SCHMIDT Technology** is an invaluable source for your assembly needs, with the center point being a press. We welcome the opportunity to evaluate your application, perform feasibility studies, process sample parts to determine process capability from a control, as well as monitoring standpoint.

We can take your applications from process development and manufacturing of prototype tooling to provide you with custom designed, turn-key solutions.

SCHMIDT® engineers and sales force have gained a wealth of experience while working on a wide array of applications.

SCHMIDT Technology products are suitable for a broad variety of industries and can be tailored to the specific requirements and challenges that applications present, from very basic and simple pressing operations to intelligent, precise and complex processes, combined with monitoring.

The ever rising need to log and exchange process data with third party systems can easily be addressed by the various ways our control systems can be interfaced.

Your need is our challenge. We look forward to the opportunity to be of service.



SCHMIDT® ElectricPress 43/343 Automation

Integrates easily and quickly into an automated system; ideal for new design concepts, integration or as a replacement in an existing production line.



SCHMIDT® Customer-Specific Solutions



"Compliant Pin" application

SCHMIDT® ServoPress Systems are the ideal tool for press-fit applications. Their integrated process data and closed-loop force control is perfect for the assembly and disassembly of electronic components. In contrast to soldering, press-fit contacts on a circuit board requires precisely defined and closely monitored assembly processes at very slow speeds. A **SCHMIDT® Press** can be the solution.

All **SCHMIDT® Press Types** can be integrated in a rotary indexing system. Depending on the requirements of the customer, an individual design is planned.

Hybrid Assembly Cell Configuration with

- a monitored PneumaticPress
- a monitored ServoPress
- a conventional HydroPneumaticPress

A single **SCHMIDT® PressControl 7000 RT** can control all of these presses as well as an indexing table. It acquires all stroke/force process data, which can then be transmitted to the **SCHMIDT® DataBase** software for storage and analysis.



SCHMIDT® Support

Close to the customer thanks to a perfect service

SCHMIDT® DemoBus

Our press technology will come to your premises. The **SCHMIDT® DemoBus** contains a selection of fully functional presses and accessories.

- See the innovative news and trends
- Get a wide overview over our products
- Do not lose time and save travel costs
- Discuss your assembly applications with our experts
- Conduct trials (by prior arrangements)



SCHMIDT® CompetenceCenter

We have a large number of presses and press systems in our exhibition and testing area at your disposal. Visitors are welcome to our Competence Center to discuss at first hand their specific requirements with our team of experts, who will be pleased to conduct trials on their tools and offer advice and best solutions for all applications.



SCHMIDT® TrainingCenter

Our training packages prepare the participants fully in theory and practice for their daily work with **SCHMIDT® Press Systems**, by offering comprehensive user training courses and seminars on complex technological products. These training courses deal with the handling of the products as well as the correct use of the control and process software. **SCHMIDT Technology** stands for high quality products and their efficient use on site.



SCHMIDT® Services portfolio

We support you either on site and from in-house

In order to meet the high quality standards of modern production, to comply with legal requirements periodic calibrations and safety tests of the press systems according to DIN ISO 9000, safety measures are required.

SCHMIDT Technology assists you by means of a strong service package in meeting these requirements.

SCHMIDT® Calibration

for force-monitored press systems

SCHMIDT® PressControl

- Checking the measurement system
- Calibration
- Issue of a test certificate incl. test report
- Calibration sticker on the machine

SCHMIDT® SafetyCheck

for all **SCHMIDT® PressSystems** with type approval

- Test according to the relevant standards
- Measurement and test of the two-hand switching
- Follow-up measurement
- Functional safety check
- General functional check
- Issue of a test report
- Test sticker on the machine

For Light Curtain Systems

- Additional test according to the relevant standards



Service Center world wide

Headquarters

SCHMIDT Technology GmbH

Feldbergstr. 1 · 78112 St. Georgen im Schwarzwald
Germany

support@schmidttechnology.de · Phone +49 7724 899 300

Service Center US – 24/7 Hotline

SCHMIDT Technology Corp.

280 Executive Drive
Cranberry Township, PA 16066
USA

service@schmidtpresses.com · Phone +1 (724) 814-5241

Service Center Asia

NIXMA TECHNOLOGY CO., LTD.

9/79 Moo 5, Phaholyothin Road, T. Klong Nueng,
A. Klong Luang, Pathum Thani 12120
Thailand

www.schmidtservicecenter.asia · Phone +66 2902 2394

Service Center Hungary, Bulgaria, Romania

Eckerle Industrie Kft.

Dózsa György út 44 · 6200 Kiskörös
Hungary

info@hu.eckerle-gruppe.com · Phone + 36 (0) 78 / 511 400

Telephone support

Our service is available Monday through Friday from 7:30 am to 4:30 pm (GMT +1). Emergency telephone assistance and a reaction time within 24 hours are our standard.